

***Getting Started***

***In***

***MicroSurvey<sup>®</sup> CAD2005***

***By***

***MicroSurvey Software Inc.***

**© 2005 MicroSurvey Software Inc.  
*All Rights Reserved***



## **Disclaimer and Limited Warranty**

This document and the software contained herein may not be reproduced in any fashion or on any media without the explicit written permission of MicroSurvey Software Inc.

EXCEPT AS OTHERWISE PROVIDED IN THIS AGREEMENT, MICROSURVEY SOFTWARE INC. SPECIFICALLY DISCLAIMS ALL WARRANTIES, EXPRESSED OR IMPLIED, INCLUDING BUT NOT LIMITED TO IMPLIED WARRANTIES OF MERCHANTABILITY AND FITNESS FOR A PARTICULAR PURPOSE., TO DEFECTS IN THE DISKETTE OR OTHER PHYSICAL MEDIA AND DOCUMENTATION, OR TO OPERATION OF THE PROGRAMS AND ANY PARTICULAR APPLICATION OR USE OF THE PROGRAMS. IN NO EVENT SHALL MICROSURVEY SOFTWARE INC. BE LIABLE FOR ANY LOSS OF PROFIT OR ANY OTHER COMMERCIAL DAMAGE INCLUDING, BUT NOT LIMITED TO, SPECIAL, INCIDENTAL, CONSEQUENTIAL, PUNITIVE OR OTHER DAMAGES.

ALL LIABILITY BY MICROSURVEY SOFTWARE INC. HEREUNDER IS EXPRESSLY LIMITED TO ANY AMOUNTS PAID TO MICROSURVEY SOFTWARE INC. PURSUANT TO THIS AGREEMENT.

Notwithstanding any provision of this Agreement, MicroSurvey Software Inc. owns and retains all title and ownership of all intellectual property, including but not limited to all software and any and all derivative software; all documentation, manuals and related materials; all master diskettes or CD ROM's on which such software may be transferred, and all copies of any such diskettes or CD ROM's, and any and all derivative works of MicroSurvey CAD 2005, or MicroSurvey inCAD by MicroSurvey. MicroSurvey Software Inc. does not transfer any portion of such title and ownership, or any goodwill associated therewith; and this Agreement shall not be construed to grant any right or license, whether by implication, estoppel or otherwise, except as expressly provided herein.

MicroSurvey CAD 2005 was created by MicroSurvey Software Inc.  
© Copyright 2005 MicroSurvey Software Inc.

All Rights Reserved

MicroSurvey is registered at the US Patent and Trademark Office, by  
MicroSurvey Software Inc.



---

# Table of Contents

<b>Table of Contents</b>	<b>i</b>
<b>Welcome</b>	<b>1</b>
<b>Addresses and Phone Numbers</b>	<b>2</b>
<b>Calling for Technical Support</b>	<b>3</b>
VIP Support Program .....	5
Copyright Notices .....	6
Hardware Requirements .....	7
Software Requirements.....	7
<b>Getting Started</b>	<b>8</b>
Help System.....	8
What's This? Help .....	9
Installing the Program .....	10
<b>The Convertible Demo</b>	<b>10</b>
Demo Mode .....	10
Register .....	11
Program User Interface.....	17
Desktop Configuration .....	18
How MicroSurvey CAD 2005 Works .....	19
Workflow .....	20
Files types used by MicroSurvey CAD 2005 .....	22
<b>MicroSurvey Assistant</b>	<b>25</b>
Assistant Main Menu.....	25
Assistant - Set Program Defaults .....	26
Assistant – FieldGenius Tools .....	26
Assistant - Send/Receive Data from Data Collector .....	27
Assistant - Import ASCII File or DC File.....	27
Assistant - Traverse Calcs .....	27
Assistant - COGO/Calculating Programs.....	28
Assistant - DTM/Contouring/Volumes.....	29
Assistant - 3D Design Programs.....	29
Assistant - Label Drawing .....	30
<b>Data Collector Tutorial</b>	<b>31</b>
Starting the Job .....	32
Importing a Data Collector File .....	33

---

Viewing the Drawing .....	39
Line Connection – Z-coding .....	41
Create Surfaces .....	43
3D Viewing and Advanced Rendering .....	47
Cleanup of screen .....	48
Quick Contours .....	49
Setting up a Boundary.....	51
Final Contours.....	53
Labeling Contours and Saving Your Work.....	55
<b>Simple Traverse Tutorial</b>	<b>59</b>
Starting the Job .....	60
Setting the Defaults.....	61
Manual Traverse Entry.....	64
Start Entering Shots .....	68
List of Data to Enter .....	70
Coordinating the Traverse.....	75
Computing Closure .....	79
Adjust Angles + Compass Balance.....	83
Listing the Traverse.....	86
<b>Property Line Tutorial</b>	<b>89</b>
Starting the Job .....	90
COGO Calcs (Property Boundaries).....	93
Distance/Distance Intersection .....	97
3 Point Curve .....	98
More COGO .....	99
Bearing/Distance Intersection .....	99
And More COGO.....	101
More 3 Point Curves .....	103
Setting the Toggles .....	104
Locating the Buildings (Using OFFSETS).....	106
Work on the SHED .....	110
Line Inverse.....	114
Job Complete .....	114
Final property drawing.....	115
<b>Earthwork Volume Tutorial</b>	<b>118</b>
Starting the Job .....	119
Setting the Defaults and Toggles.....	119
Importing a Data Collector File .....	122
Creating the Traverse File.....	124
Processing and Editing the Traverse File .....	126
Coordinate the Traverse .....	127
Working with AutoMAP .....	129

---

Start the First Surface .....	136
Make the First TIN.....	138
Start the Second Surface.....	139
Extract the Second Surface .....	140
Make the Second TIN .....	141
Calculate Volumes between the 2 Surfaces .....	142
Cross Sections across the Job .....	144
<b>Road Design Tutorial</b>	<b>149</b>
Opening the Job.....	149
Create the Ground Surface.....	151
Inputting the Horizontal Alignment.....	155
Stationing and Saving the Horizontal Alignment.....	158
Create Profile .....	161
Design New Profile.....	163
Create Cross Section Template.....	168
Create New Road Surface.....	171
Output Cross Sections .....	173
<b>House Placement Tutorial</b>	<b>178</b>
Open the Job.....	178
Working with the Toolbox.....	181
Entering a Lot.....	181
Defining the Lot Sides .....	187
Entering a House .....	190
Defining a House.....	195
Placing a House on the Lot.....	197
Computing Stakes.....	201
Staking Reports.....	203





---

## Welcome

MicroSurvey Software Inc. is pleased to present our flagship product - **MicroSurvey CAD2005**. This version contains one of the biggest changes we have ever made to our software. We have switched the underlying CAD engine from the FelixCAD product to the IntelliCAD program. MicroSurvey Software Inc. has joined the IntelliCAD Technology Consortium as a full Commercial Member.

This provides MicroSurvey with capabilities that we have dreamed about for more than 15 years. Specifically this means that MicroSurvey now has the source code to the CAD engine! With the source code we can start to make small changes to improve your experience in very special ways. As a small example, we can carefully integrate the UNDO and REDO commands to understand surveying data. Much more will come in time.

Included with this program are 160 training movies and extremely comprehensive on-line help. Movies help make the printed documentation obsolete. That is why we reduced our manuals to a "Getting Started" book that contains the tutorials in a lay-flat book. Since the help system is electronic, we can treat it as a living document that can be updated with each service pack or new CD.

We plan on introducing more exciting products for you in the next year. Watch our web site for news and updates on this and other MicroSurvey products.



Yours truly,

Darcy Detlor,  
President,  
MicroSurvey Software Inc.

---

## Addresses and Phone Numbers



**MicroSurvey Software Inc.  
Corporate Head Office  
MicroSurvey Software Inc.  
#110 – 2300 Carrington Road,  
Westbank, BC, V4T 2N6  
Canada**

Office Hours: *8am to 5pm Pacific Time.*  
(Monday to Friday, except holidays)

Sales & Technical Support 1-800-668-3312  
International Voice: +1-250-707-0000  
Fax: +1-250-707-0150

Internet web-site <http://www.microsurvey.com>  
General Information: [info@microsurvey.com](mailto:info@microsurvey.com)  
Support E-Mail Addresses: [support@microsurvey.com](mailto:support@microsurvey.com)

---

<u>Eastern Technical Support Office</u>	Office Hours: <i>8:30am to 5:00pm Eastern Time.</i> (Monday to Friday, except holidays)
MicroSurvey Software Inc.	Technical Support Number: 1-877-752-2911
3427 Hwy.#17 East, RR #2	International Voice: +1-705-752-2911
Corbeil, Ontario, P0H 1K0	Fax: +1-705-752-2133
Canada	

---

# Calling for Technical Support

## Preparing to Contact Technical Support

MicroSurvey Software Technical Support is available to help you get the most out of your MicroSurvey CAD 2005 program. The following information explains how to prepare for your call so that your inquiry can be answered promptly and accurately. Take a few minutes before you place your call to check the printed documentation and the on-line help files to see if the answer is already at your disposal. Remember that there are several tutorials and over 150 Movies that can also help explain some topics. Our Web site on the Internet can also save you time, please check it for assistance if you can. If they do not help you then when you call please have the following information available if requested. Computer brand and model, CPU type and clock speed, other hardware attached to the computer such as plotters and digitizers, version of the program, operating system and version.

Please make sure that you have all the steps you completed prior to your problem and can explain them to the technical support representative. We may ask that you forward a copy of your data to us if we cannot find the problem immediately.

## Phone/Fax Support

### Introductory Support

MicroSurvey offers a 90-day complimentary support period to all of our registered users, starting the date of purchase. Introductory support is available Monday to Friday except holidays. To reach a technical representative you may use one of the following;

### **Pacific Time Technical Support (Head Office): 8:00AM-5:00PM**

Technical Support Number: 1-800-668-3312

International Customers Please phone: +1-250-707-0000

Technical Support fax number: 1-250-707-0150

### **Eastern Time Technical Support Office: 8:30AM-5:00PM**

North American Technical Support Number: 1-877-752-2911

International Technical Support Phone Number: +1-705-752-2911

Technical Support fax number: 1-705-752-2133

### **Yearly Support**

---

For clients who have had their original 90-day complimentary support period expire and feel that they will want on going support over the next year, we have a Yearly Support Contract option available. This gives you the ability to contact us for technical support, as much as you require, and you pay a flat fee once a year. This option is not to be used in place of training but is to assist you on the occasions when you really need it. The charge for the Yearly Support Contract is to be billed and paid for prior to the support commencing. This rate is subject to change, call for current rates.

## **Electronic Support**

MicroSurvey maintains and provides support at no charge on our Internet Web-site at the following address:

<http://www.microsurvey.com/>

This web-site has sections on Frequently asked questions, Technical Notes, Technical Specifications, and as required, free updates and program fixes, along with a lot of other helpful information.

## **Training**

MicroSurvey Software Inc. can provide training to you, in your office or in a classroom situation (where facilities and numbers allow).

MicroSurvey has training staff that will travel to almost anywhere and provide you with the professional skills you require to operate your MicroSurvey CAD 2005 program. Please feel free to call and ask for a quotation or inquire about potential classroom situations. Your local dealer may also be able to setup or arrange a training session for you. Contact our head office for more information about training.

---

## VIP Support Program

Keep on top of the technology with MicroSurvey's VIP Software Subscription program. You don't need to concern yourself about staying current – we'll do it for you. It's the worry-free way to ensure you always have the best, most up to date software anywhere, and you know exactly how much it will cost. You'll also receive unlimited technical support for your software.

### What are the advantages?

- Get all upgrades to MicroSurvey CAD 2005 sent to you automatically and **Free!**
- **Unlimited telephone support included.** You always talk to a real person when you call MicroSurvey's support line.
- With VIP Service, we'll always **start the support process with a real person within 1 hour** of your call. (during regular business hours\*)
- Always keep up to date with the latest technology. We give you priority e-mail notification of all bug fixes and updates.
- You receive a **10% discount** on your future MicroSurvey software purchases (from regular or promotional pricing)
- No need to generate new purchase orders each time that a new upgrade is released. Your upgrade will come automatically.
- **Is your peace of mind worth pennies per day?** These days, you can hardly buy a cup of coffee for that price, but that's all you'll pay for MicroSurvey's VIP Subscription Program!
- Buy up to four years' Subscription at once. You'll know exactly what it's going to cost you, and you don't ever need to check if you have the most current MicroSurvey software version.
- **We pay the shipping for new software.** That's another thing you won't have to worry about.
- When you deal with MicroSurvey, you always get great service. Imagine how good the service will be when you're a VIP!

Call our office for more details on the VIP program, or see the MicroSurvey web site.

(\*Note: 1 hour call back guarantee to start the support process is during Western Office hours)

---

## **Copyright Notices**

**MicroSurvey CAD 2005**

**© Copyright 2005  
MicroSurvey Software Inc.  
All Rights Reserved**

MicroSurvey Software Inc. reserves the right to revise and improve its products as it sees fit. This publication describes the state of the product at the time of publication, and may not reflect the product at all times in the future. Use and disclosure of this product is governed by a licensing agreement printed. No part of this product may be disclosed or otherwise made available without prior written authorization.

MicroSurvey® is a Registered trademark of MicroSurvey Software Inc. All other trade names or trademarks are gratefully acknowledged as belonging to their respective owners.

---

## **Hardware Requirements**

MicroSurvey CAD 2005 operates entirely within Windows, and has no hardware requirements over and above those of Windows itself except as noted below. We suggest the following basic system as a minimum for *efficient* operation:

- Pentium processor – 1000 MHz minimum – the faster the better!
- 512 megabytes RAM (1024MB or more if you are working in large drawings most of the time)
- 1 Gigabyte of free hard disk space
- Video resolution set to 1024X768 or better (lower resolutions may result in part of the pull down menus running off the bottom of the screen)
- Mouse, digitizing tablet or other pointing device

In order to use the data collector communication features, your system will also need an external RS-232 serial port or a USB connection for best performance with MicroSurvey FieldGenius™.

In order to get printed output, you will require a printer or plotter configured to work in your Windows environment. We recommend obtaining the most up-to-date printer/plotter drivers off of the manufacturers Internet web site.

## **Software Requirements**

MicroSurvey CAD 2005 is designed for use with Windows 98 (Second Edition), Windows ME, Window NT (4.0SP5+), Windows 2000, or Windows XP. Note: Windows NT, 2000, and XP users must have Administrator's rights to authorize MicroSurvey.

When using a digitizing tablet you will require the current WINTAB driver for your tablet, and it must be installed and configured in Windows.

---

## Getting Started

### Help System

The help system is continually updated to keep current with all the advancements and new commands that are added on a regular basis. The help file also has Tutorials, Important Phone Numbers, Copyright Information, and Much more. Be sure to look through the whole help file as **it will always be more current and comprehensive than the manuals.**

#### **A few tips about using Help:**

You can find Help using any one of these 3 methods:

1. By clicking on the HELP button available on most dialogs within MicroSurvey CAD 2005. This will take you to the help topic on the command currently in use.
2. Quick tips are available on most dialogs within MicroSurvey CAD 2005 by using the What's This? Help.
3. Access the Help System from the top of the Help menu or using the F1 key. If you have highlighted a menu item, press F1 to jump to it in the on-line help.

Have a look at the next image. The Help is arranged in the same basic order as the Menus.

- Notice that the topic for drawing a LINE is displayed. If you had located this topic using the Index or Search options, you should flip to the Contents option to locate the command in the menu system.
- Notice that the keyboard command is shown where possible as well as the corresponding toolbox / Palette button.
- The Back button will take you to the last page viewed and the forward and back arrows help you to navigate through the Help system in topic order as shown in the table of contents.
- Always look for the vertical scroll bar on the far right hand side. It's presence indicates that there is more information below that is not currently visible. Some topics are several pages long!



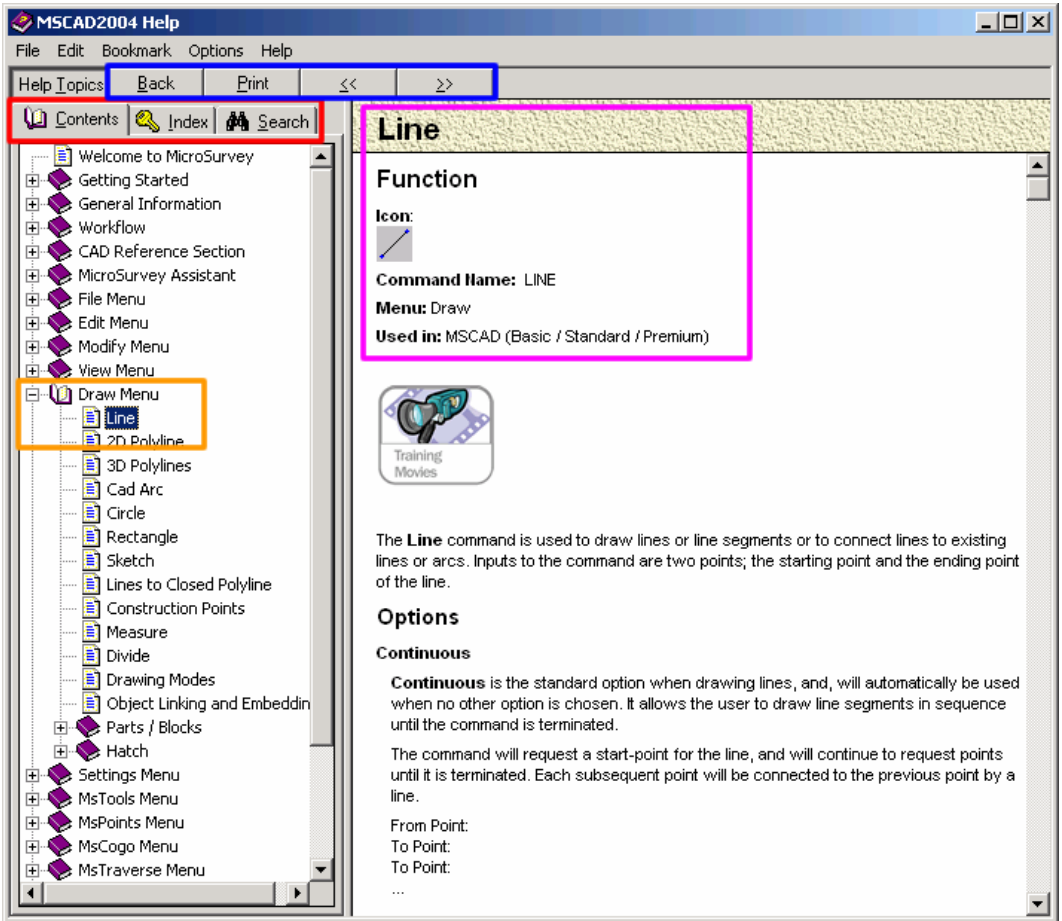

## What's This? Help

The little  in the corner of the dialog box allows you to pick it then pick the portion of the dialog that you want help on while running the command.

Use this to find out about any portion of the dialog box on screen.

---

## Installing the Program

Please run Setup.exe on the CD to install MicroSurvey CAD 2005. Follow the prompts to install the program.

## **The Convertible Demo**

MicroSurvey CAD 2005, like other MicroSurvey Software Inc. products, is marketed in the form of a "Convertible Demo", which lets you try out all its functions without buying a copy. You can obtain a copy of the entire package by mail for a nominal shipping and handling fee; we also encourage you to redistribute copies to anyone in complete and unaltered form. This copy will be fully functional in every way but will shut down after 30 days.

If you decide to purchase the system, you can convert it to full operation by means of a password supplied by MicroSurvey Software, or an authorized dealer.

When you initially start up the program, you will see the following dialog box:

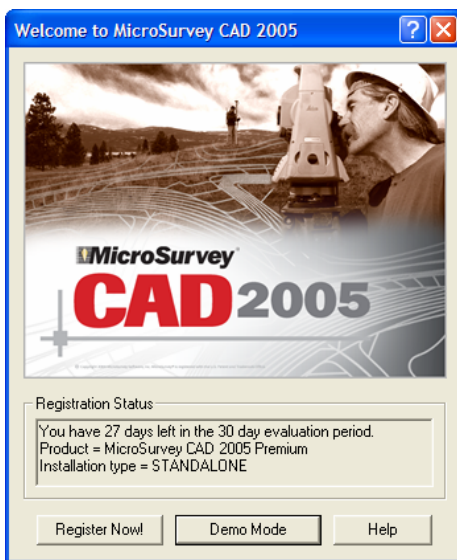

Choose one of the following Options:

### **Demo Mode**

If you are just testing the program out then you will click on the Start MicroSurvey CAD 2005 in DEMO Mode button.

---

## Register

### Step 1)

If you choose Register Your Copy of MicroSurvey you will see the following dialog box:

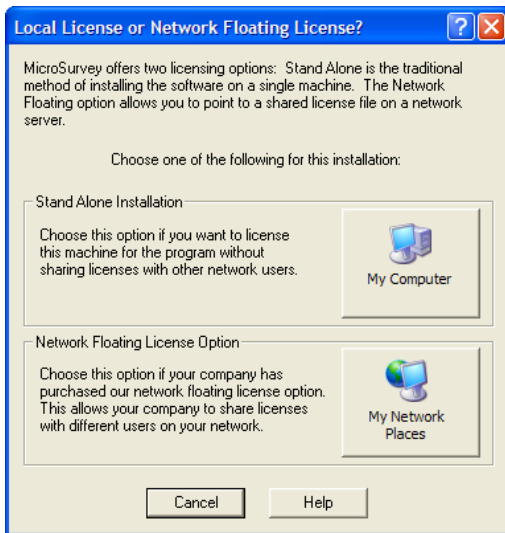

The program can be registered in two modes:

- Stand Alone Installation
- Network Floating License

The remainder of this section will cover the Stand Alone Installation. If you have purchased a Network Floating License, please see the document that was supplied entitled “Network Floating Licenses with MicroSurvey Products”.

### Step 2)

Choose the Stand Alone Installation (My Computer Button)

You will see the following dialog:

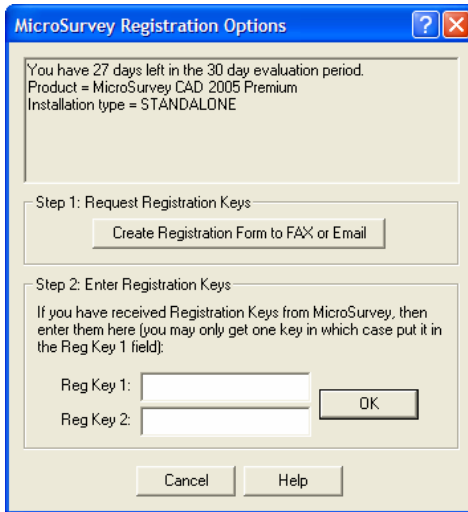

### Step 3)

Press the “Create Registration Form to FAX or Email button, and please fill in the following dialog: (we have entered sample information)

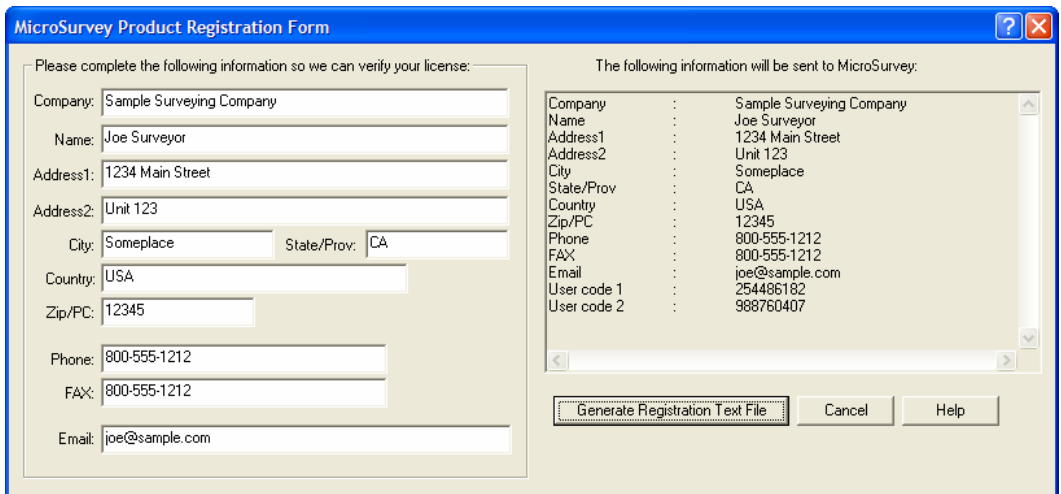

### Step 4)

Press the “Generate Registration Text File” button and a document called “register.txt” will open in Notepad:

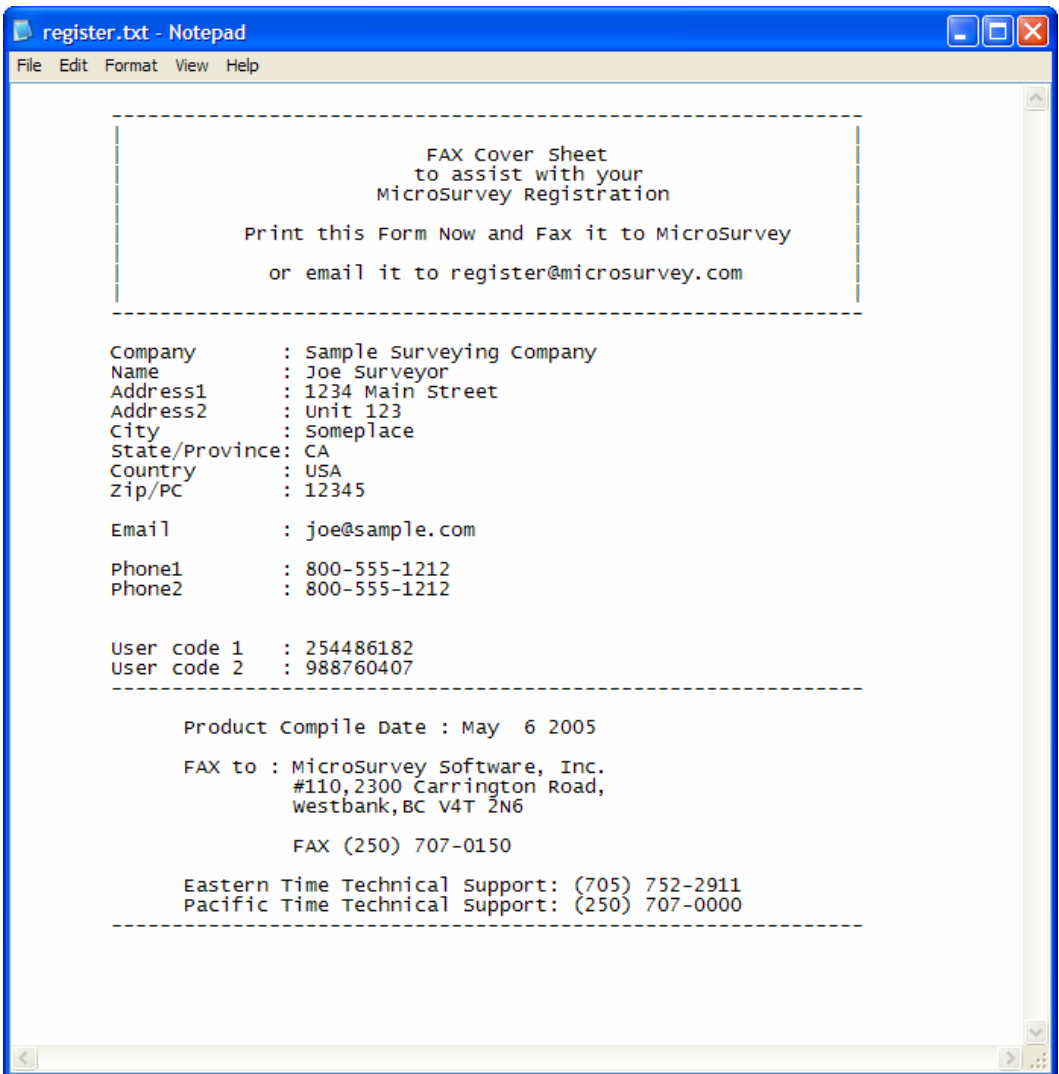

### Step 5)

Please print this document and FAX it to (250) 707-0150 or email it to [register@microsurvey.com](mailto:register@microsurvey.com)

---

## Step 6)

For a Stand Alone Installation, you will be provided with a single number. Only one number is required. Please enter the number you are provided in the dialog: (sample number is entered) and press OK.

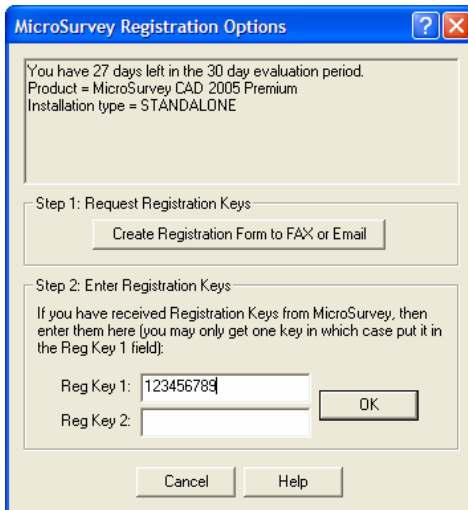

## Step 7)

The program will advise you that the product will be registered the next time you start it up. Exit the program and restart to make sure that you are no longer prompted for a password.

## Transferring License

With MicroSurvey CAD 2005 we have introduced the ability to transfer your license to a different computer. This is useful when you are upgrading to more powerful machines. You will need to have access to both machines. Both machines need to have MSCAD 2005 installed with one of the machines in a licensed state. You will need to move a file from the "old" machine to the "new" machine. This can be done with a floppy disk, network transfer, or USB memory key.

Command: MSTRANSFER

You will see the following dialog:

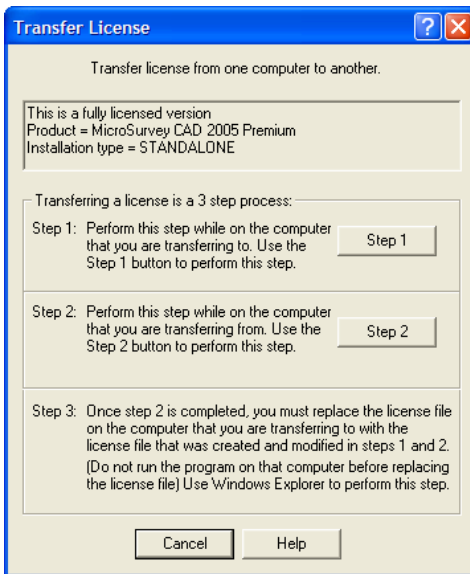

Follow the instructions on the dialog.

## **Take Home Option**

Many MicroSurvey customers would like an easy way to transfer their office license to a home machine for evening or weekend use. With MicroSurvey's "Take Home Option" we have made that easy. Here is how it works:

- You transfer the license to your home machine by moving a file called ***transfer.lic*** via floppy disk, email, or a USB memory key.
- The ***transfer.lic*** file has an expiry date in it. If you copy the file onto a machine and run MSCAD before the expiry date it will work.
- The expiry time is always midnight of the date.
- You tell the program how many days you want to use it at home.
- Today counts as "day 1".

Example:

It's Thursday and you want to work at home on Friday and Saturday, so you run the MSLICENSEFILE command. On the following dialog, you enter 3 in the bottom right corner as shown:

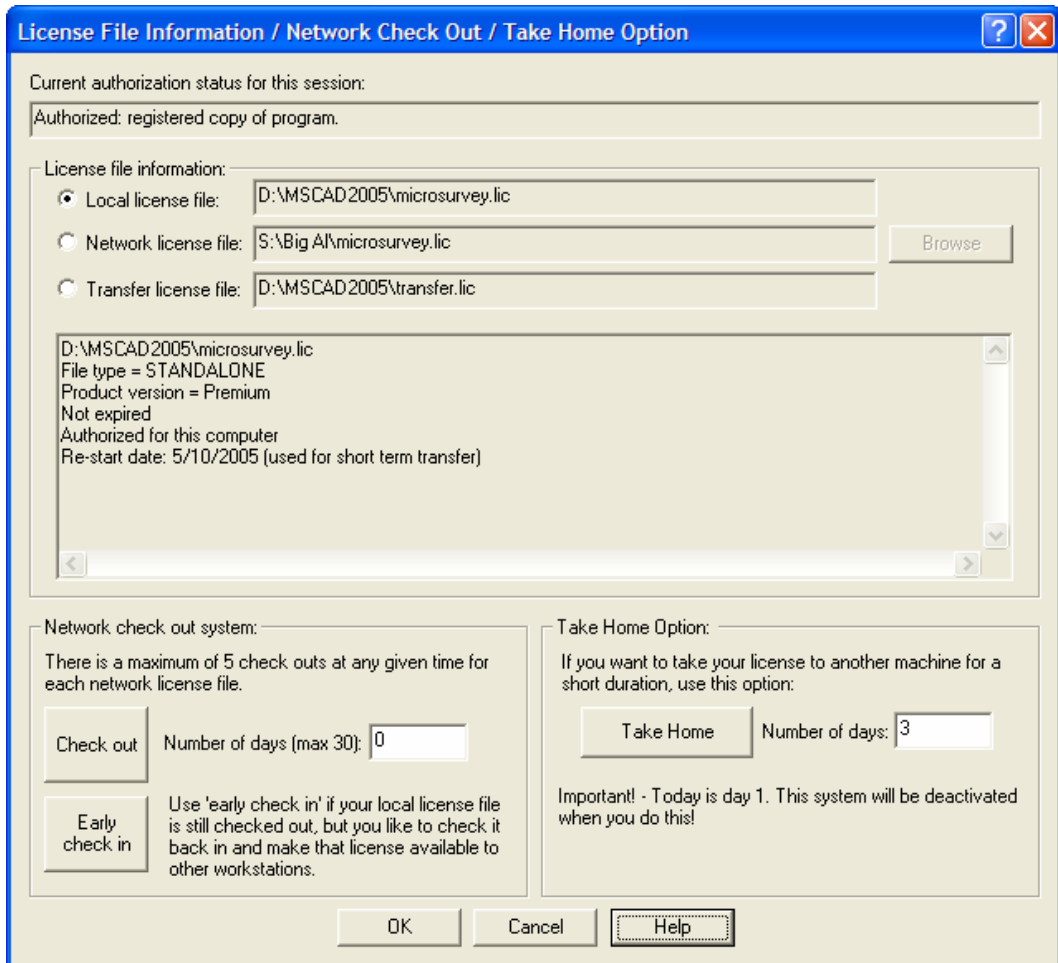

**IMPORTANT NOTE:** The program will no longer operate once you have exercised the Take Home Option. It will work correctly once the home version has expired. This is NOT reversible, so only use this option if you are certain that you will not need the office version.



## Program User Interface

The desktop contains a series of standard elements. These are the menu bar, the toolbars, the properties bar, and the status bar.

In addition, the desktop may also contain several palettes.

The following picture shows a possible standard variant of the desktop. See the on-line help system for more details.

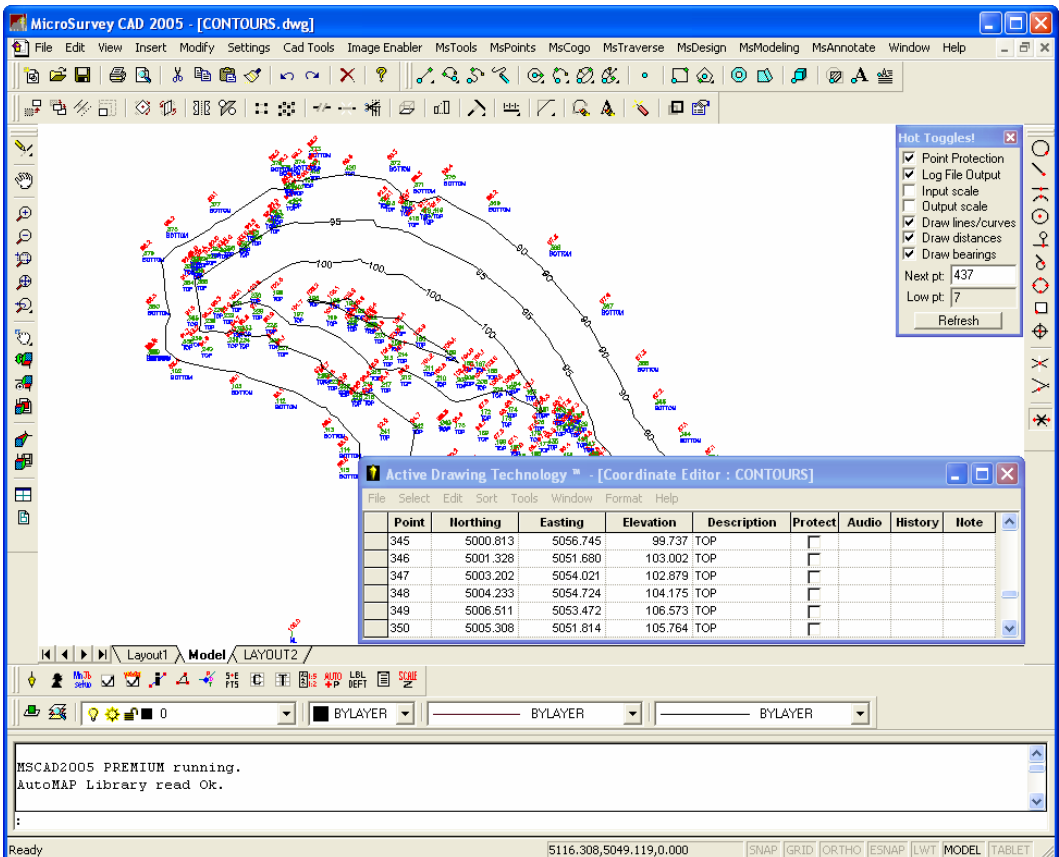

---

## Desktop Configuration

### Command Line

The command line can be placed at the top of the screen (below the menu bar), or at the bottom of the screen (above the status line). If you are an advanced user familiar with the program's command set, you might even turn off the command line.

### Properties



The property bar can be turned on or off. We recommend you turn it on.

### Status Bar

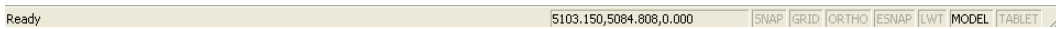

The status bar can be turned on or off. We recommend you leave it on.

### Customizing Toolbars

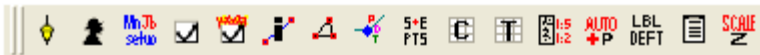

The toolbars assemble buttons that represent a common set of commands, or sequence of commands.

---

## **How MicroSurvey CAD 2005 Works**

MicroSurvey CAD 2005 creates a database that contains connectivity information, coordinate locations, descriptions, traverses, bearings, and distances. The program tracks the entities stored in the CAD drawing by their handle numbers. Many files are created to store this information.

In order to limit the number of files you need to work with, we combine the data files into one file when you close the MicroSurvey CAD 2005 job. The database is stored in a file with the extension .MSD. This file is stored wherever your CAD drawing is stored.

The MSD file is expanded into a directory that has the same name as your job with the extension .MSJ. If you are running MicroSurvey CAD 2005 and you look in the directory where your job is located, you will see this .MSJ subdirectory. When you close the MicroSurvey CAD 2005 job by exiting or closing the drawing, then the files will be automatically compressed into one file, and the directory will be removed. While you have the job open, the original .MSD file is rename to .MBK and it serves as an emergency backup file.

MicroSurvey CAD 2005 has an Automatic backup timer that will save the drawing and the database regularly.

In the event that the .MSD file cannot be opened, the system will automatically attempt to open the .MBK file. If neither file can be opened (very unlikely), then the system can still reconstruct the coordinate database and the connectivity database directly from information we store in the drawing.

If you have only the drawing created in MicroSurvey CAD 2005 and no database for whatever reason, we can still recover coordinates from the drawing automatically upon opening the DWG file. This can be accomplished by running the Audit database command. See the on-line help for more information.

---

## **Workflow**

This summary is intended to provide an introduction to users who are not familiar with MicroSurvey CAD 2005 and outlines the steps necessary to prepare a survey drawing.

Generally you will be starting with data from a data collector, from field notes, or from direct COGO data entry. You may also extract data from existing CAD drawings.

When you first start MicroSurvey CAD 2005 you must either open an existing drawing (dwg, or dxf file) or start a new one. Opening an existing drawing will automatically open and link to the associated MicroSurvey CAD 2005 coordinate database (.msd file). If you start a new drawing, a new MicroSurvey CAD 2005 database file will be automatically created.

On new projects or when you open existing projects, you will be shown the Main Job Defaults. You should fill out the dialog box and set up the basic job information and scale factors. Next you will need to set the System Toggles to choices appropriate to the job. Where you start next depends on the data source. Most options can now be found on the Assistant or in the MicroSurvey pull down menus.

For data collectors you will either download directly from the data collector using the choices on the Data Collector Communication menu or reading a file from the data collector using the choices on the MsTraverse | Download Data Collector menu. For field note entry you will use the Enter Traverse command on the MsTraverse | Traverse Entry / Editing menu. For manually entered COGO data, you will use the COGO command from the MsCOGO menu. (you can simply type COGO if you wish as a short cut) For point, line and curve data in a pre-existing CAD drawing, you will use the Auto Add Points to Objects command in the MsPoints menu.

When you enter a traverse in MicroSurvey CAD 2005, either by downloading a data collector or by manually typing in the data, the program creates a traverse database. Each traverse is contained in a separate database. The databases are stored in the project directory when MicroSurvey CAD 2005 is loaded and running, and they are automatically compressed into the .MSD file when MicroSurvey CAD 2005 is unloaded.

---

**There is a set order that you should use when working with raw data information in MicroSurvey CAD 2005:**

- 1) Manually enter, load from a file or download the data into the traverse file.
- 2) If you are entering the data manually, and the Auto Coordinate toggle is ON, then points will be coordinated and drawn onto the MicroSurvey screen as you enter the data. If you download the data from a data collector, any coordinates in the ASCII file will be entered immediately in the coordinate database. The raw data shots read in from the data collector ASCII file are NOT processed into coordinates until you select Re-coordinate Traverse.
- 3) Edit the raw data to correct any known errors by selecting MsTraverse | Active Traverse Editor.
- 4) Enter any starting setup and backsight coordinates into the coordinate database before you attempt to coordinate the traverse. Use Store and Edit Coordinates on the MsPoints menu.
- 5) Select MsTraverse | Traverse Calculations | Re-coordinate Traverse. This is the program that analyzes the raw data and computes the coordinates for all the raw data shots taken in the field.
- 6) Use the MsPoints | Active Coordinate Editor to view the points. Examine the MicroSurvey drawing for errors.
- 7) Correct errors using MsTraverse | Active Traverse Editor and Re-coordinate the traverse. When you run Re-coordinate traverse on a traverse that has already been coordinated, you will trigger a point protection alert for each point processed. To avoid this, turn off Point Protection in System Toggles, then the entire traverse will then be process without interruption.
- 8) To see the line work for the traverse go to the MsTraverse | Traverse Entry / Editing | Show Traverse Graphically command.
- 9) Use the MsTraverse | Traverse Calculations | Compute Closure option to analyze the closure of the traverse.

- 
- 10) You may balance the traverse using one of several options, Angle Balance, Transit Balance, Crandall's, Least Squares, or Compass Balance. See Traverse Balancing in the on-line help for details.
  - 11) If you detect an error after balancing, you can revert back to the original or edited traverse and re-coordinate it again starting at step

For more examples of MicroSurvey workflow, please see the Tutorials

### **Files types used by MicroSurvey CAD 2005**

#### **An outline for how MicroSurvey CAD 2005 saves your drawings.**

A suggested folder name to save your jobs in might be C:\JOBS2005. Then create a new one for 2006, etc. as desired. We do NOT recommend that you place your jobs in our MSCAD 2005 folder or in a sub folder under MSCAD 2005. Also - try and keep your folder names simple and not too many levels deep. The job name should also be kept simple. Under this folder you can have many jobs, each with its own name. When you start a new job or open an existing job, there are several files created automatically on the hard drive in the folder you selected.

Below is an example of what files are created by MicroSurvey - using the file JOBNAME.

#### **Standard Job Files:**

Drawing File	→	jobname.dwg
Database File	→	jobname.msdb
Temporary Folder	→	<dir> jobname.msj
Backup of Drawing file	→	jobname.bak
Backup of Database file	→	jobname.mbk

Note that for MicroSurvey CAD 2005 you can set the program to store all files in DWG format from R2.5-R2005.

When the Job is opened, the Drawing file goes into your computer memory, and the Database file is opened into a temporary folder. The temporary folder has the same name as the JOB but has an extension of MSJ attached to it.

---

You should not touch this folder and nothing should be placed in here except via the automated routines in our program. We place this temporary MSJ folder in the same location on the hard drive as the job. **This is why you cannot open a job from your floppy drive as it is too slow and does not have enough space!**

When you save the job, the contents of this folder are compressed and saved into the MSD file. If you exit the program this folder is erased, along with everything in the folder. This is why you should not place anything in this folder yourself.

Each time you save the job you are taking the current information in memory and saving it to the DWG file. Then we take the current contents of the MSJ folder and save it to the MSD file. At the same time, if a DWG and MSD file already exist then we rename the copy already on the hard drive. The DWG file becomes the BAK file, and the MSD file becomes the MBK file. This way you have backups of your work in case you need them. If a BAK file and MBK file already exist then they are simply replaced by the newer copy.

As you work through a job you will create other files as well. The LOG file is saved automatically in the same folder as the DWG file. This file maintains a record of the survey commands run with their output. There is a toggle to control this file as well as the ability to blank the file.

If you do any work in the Modeling menu and you decide to save your surfaces then you will create a QSB file. We suggest you save it in the same folder as the DWG file as well. This QSB file is not automatically saved and must be done manually - also for loading it must be done manually each time you wish to use it in the job.

The program will also save Raster functions in the FLI file and any Helmert's Transformation data sets in the HELMERTS.BIN file.

*Drawing Calculations Log File -> JOBNAME.LOG*  
*Modeling Surface File -> JOBNAME.QSB*  
*Raster Images File -> JOBNAME.FLI*  
*Helmerts Transformations File -> HELMERTS.BIN*

Other files can be generated, depending upon what you do in the program. If you download a data collector you may have a Raw data file or a Coordinate file. You must tell us where to save these files on the hard drive and in some cases

---

even what to call them. We might suggest one of two locations to place these files. First might be a folder called C:\DOWNLOADS, it would be at the same level as JOBS2005 but separate. Second you may want to place the DOWNLOADS folder under the JOBS2005 folder producing, C:\JOBS2005\DOWNLOADS as a location to save all your download files. This is up to you.

Depending upon what type of collector you are using, the file names may be sent directly from the collector to our program. Other brands will require you to provide the name and extension. If you are providing the name then be sure that it reflects your job name, is unique and has an extension on it.

Suggested extensions might be RAW for raw data files and COR or TXT or ASC for coordinate files. (TDS collectors use RW5 for raw files and CR5 for coordinate files, and both use the name stored in the collector automatically) Or course there are many other files that you can create with MicroSurvey, they can range from Report files and closure files, to ASCII exported files and upload collector files, and even Legal Descriptions. You can name these anything you desire but we recommend that the naming structure be consistent and use appropriate extensions, and always keep the files together in the JOBS2005 folder so you know where the files are. We allow you a lot of flexibility but you have the ultimate control and if you do not know how to work in Windows to create the correct folders then you may wish to receive some training in this area before jumping in too deep.



---

## MicroSurvey Assistant

These menus are designed to assist you in developing a job from first principles to completed survey drawing, with minimal knowledge by the user.

### Assistant Main Menu

The main menu is structured so that no matter what you have to do to start a job, you should be able to do it directly from here.

As you move your mouse around on the assistant, you will see different pictures appear for each of the buttons. They are there to help you remember what each button will do for you. Picking on one of the buttons will take you to a second level of menus that provide more programs. Investigate them all so you will know where to find what you need.

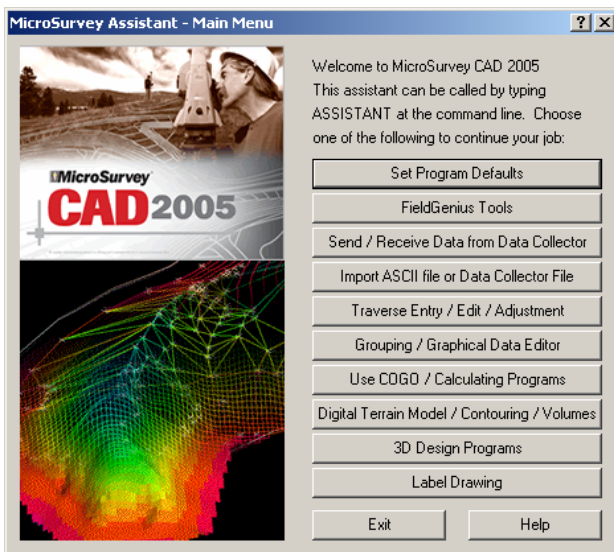

---

## Assistant - Set Program Defaults

Use this dialog to modify the Program Defaults.

You can modify the Main Job Defaults under the General button. The Toggles are also available to you from this dialog, along with all the other defaults used to setup such things as distances, elevations, point numbers, etc. The CAD Settings and Drawing Units will display the appropriate options allowing you to set the working units, grid, snap, point style, OSNAPs, trim radius, highlighting options, mirror text options, and a whole lot more.

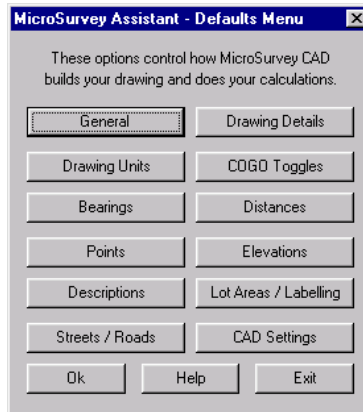

## Assistant – FieldGenius Tools

MicroSurvey's FieldGenius line of data collectors has a super productive and easy to use interface. Our extensive experience with a variety of manufacturer's data collectors ensured that when we built an interface, it would be better than anything on the market. Our ActiveSync integration makes data transfer and import as painless as possible.

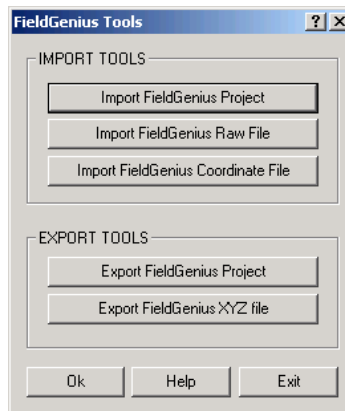

---

## **Assistant - Send/Receive Data from Data Collector**

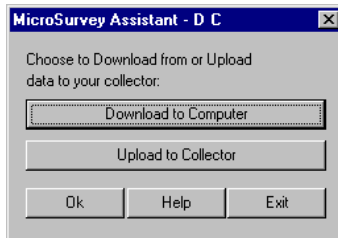

This short menu assists you if you are downloading a file from your data collector to the computer or uploading a file from the computer to your data collector.

## **Assistant - Import ASCII File or DC File**

Another method of importing point data into MicroSurvey CAD 2005 is via an ASCII file. This file would have information like; Point Numbers, Northings, Eastings, Elevations, Descriptions, each describing a point, and in one of several different formats in a text file known as an ASCII file.

You can also read a data collector file that you downloaded previously, incorporating the data into your job.

Several other tools have been added to this menu to allow you to join points by linework in an automated method.

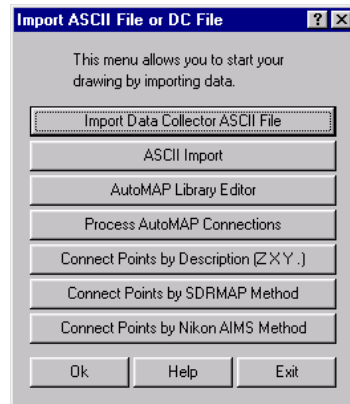

---

## Assistant - Traverse Calcs

This menu option allows you to manually enter, edit, list, re-coordinate, or show a traverse. It also allows you to compute closures and balance the traverse.

Data collector files are also considered to be traverses and therefore you have the ability to manipulate those files as well. Especially useful for the data collector file is the Re-coordinate traverse option which is required to calculate coordinates from the original Raw data saved in your data collector files.

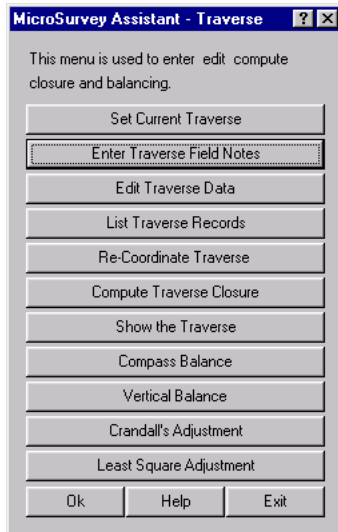

## Assistant - COGO/Calculating Programs

Here are the shortcuts used by almost everyone. COGO is one of the most used portions of MicroSurvey CAD 2005. Working with lines and curves, generating streets from centerlines, and then taking those streets and adding blocks and lots to create a subdivision. Finally this section allows you to take the lots and place houses on them, with labeling of the lot numbers and areas.

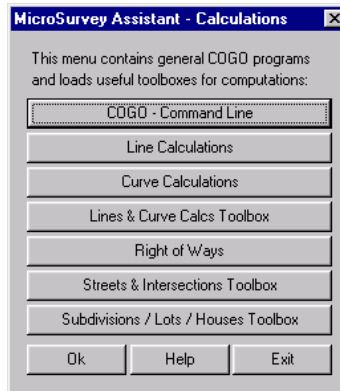

---

## Assistant - DTM/Contouring/Volumes

For the customers that need to take their survey drawings a step further and create surfaces from the point and line data, we have made the transition to the Modeling program as seamless as possible. The more common activities of creating Surfaces, TINs, Contours, and continuing further to calculate volumes between multiple surfaces, are all made available to you here along with many other options.

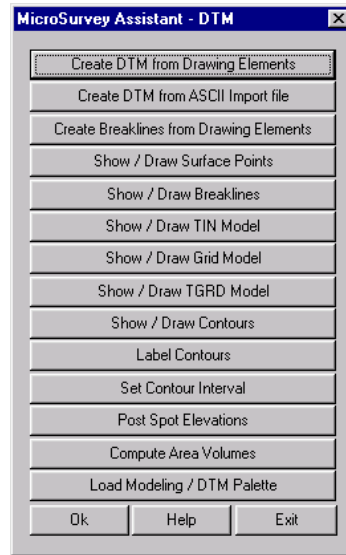

## Assistant - 3D Design Programs

This menu is used for the more advanced design sections of MicroSurvey CAD 2005. These routines are explained in detail in the Help system.

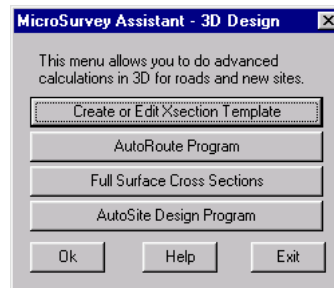

---

## **Assistant - Label Drawing**

This menu is a short cut to all of your text and labeling routines. Many of the Toolboxes can be accessed here to help make rapid labeling possible. Other routines such as line and curve tables and area calculations are added to assist you. The toolboxes, or palettes, display many options and can be left on the screen for future usage.

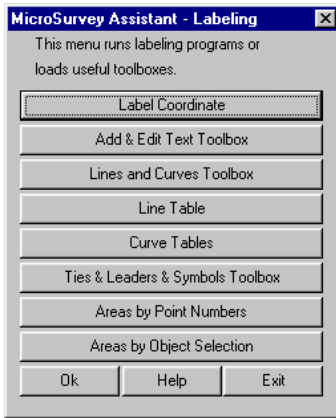

---

## **Data Collector Tutorial**

Because of the size and complexity of this tutorial we have broken it down into 11 smaller steps to make it easier for you to follow.

Step 1) Starting the Job

Step 2) Importing a Data Collector File

Step 3) Viewing the Drawing

Step 4) Line Connection – Z-coding

Step 5) Create Surfaces

Step 6) 3D Viewing and Advanced Rendering

Step 7) Cleanup of Screen

Step 8) Quick Contours

Step 9) Setting up a Boundary

Step 10) Final Contours

Step 11) Labeling Contours and Saving Your Work

---

## Starting the Job

In this introductory tutorial we will load a data collector file and annotate the points, connect the break lines, then build a contoured topographic model of the surveyed site. We will start with a new empty drawing and project and build everything from scratch.

To begin, start a new drawing by going to the **File Menu** and executing the **Project Manager** command.

Pick the New button on the Project Manager:

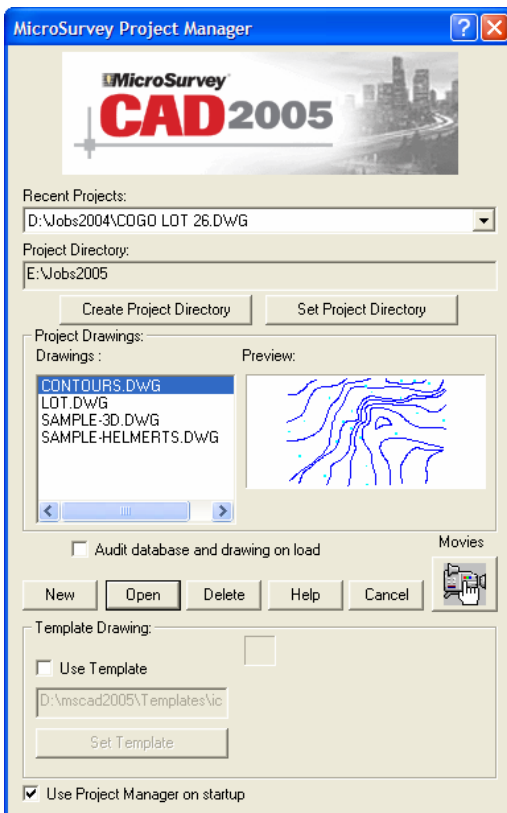

Then fill in the name of the job and call it SOKKIA.DWG,



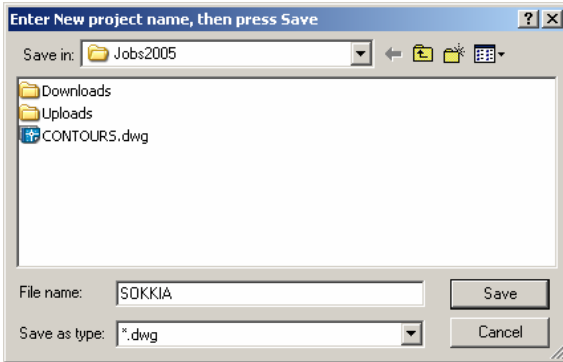

Pick on the **Save** button.

Next you will see the following dialog box.

Set the scale and other settings as shown below.

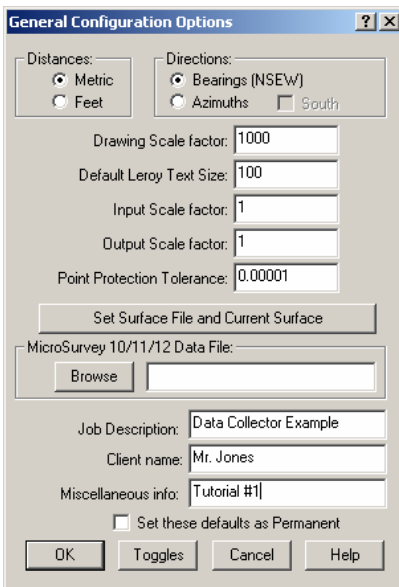

Pick on the **OK** button to continue.

---

## Importing a Data Collector File

You will see the MicroSurvey Assistant on screen (if you do not, pick on the Assistant button from the option bar)

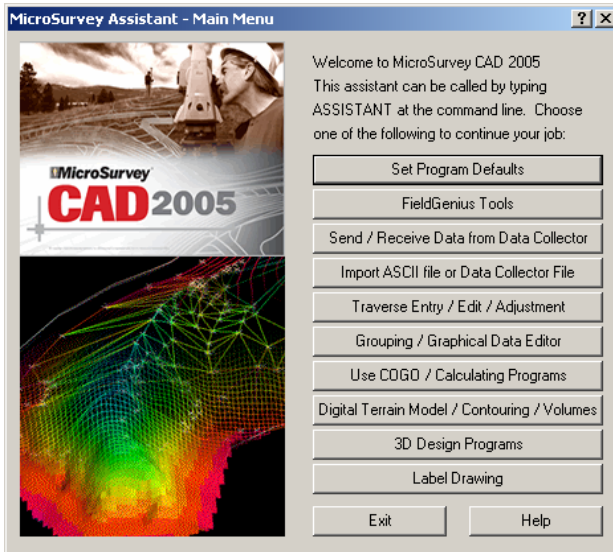

From the assistant pick the **Import ASCII File or Data Collector File** button.

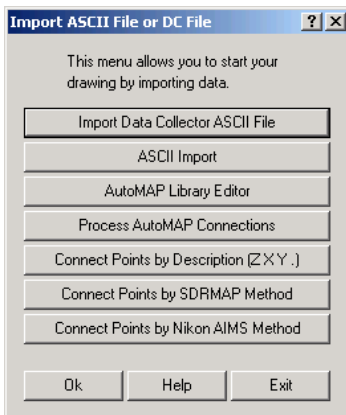

Then from this dialog pick the **Import Data Collector ASCII File** button.

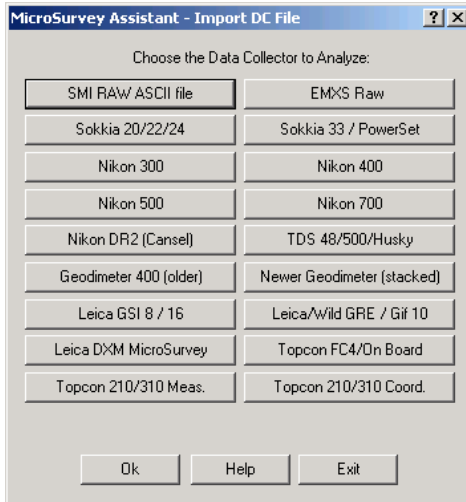

Now select the button that says **Sokkia 20/22/24**.

You will then be presented with the Toggle Check dialog box to confirm that they are correct or to change them if required.

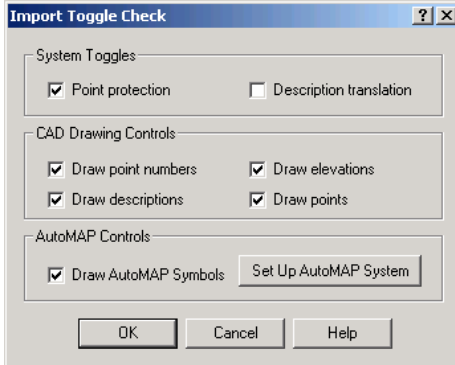

Pick the **OK** button to continue.  
Next you will see the following dialog.

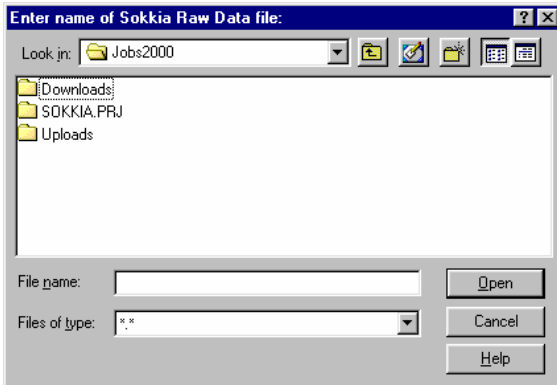

Change it to the **MSCAD 2005\Tutorial** folder and pick on the file named **SOKKIA.RAW**.

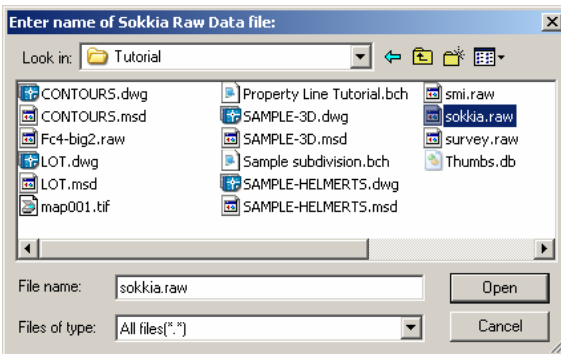

Then pick on the **OPEN** button to continue. This is a Sokkia coordinate data collector file.

Then you will see the following dialog box:

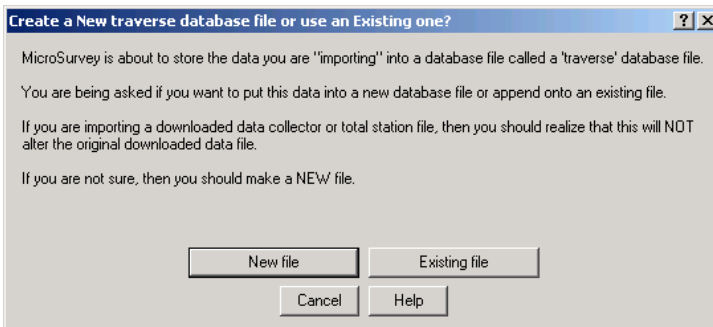

---

Select **New Traverse**, because this is a new traverse database. Enter **Sokkia** as the new traverse name in the following dialog box, and pick the **SAVE** button to continue.

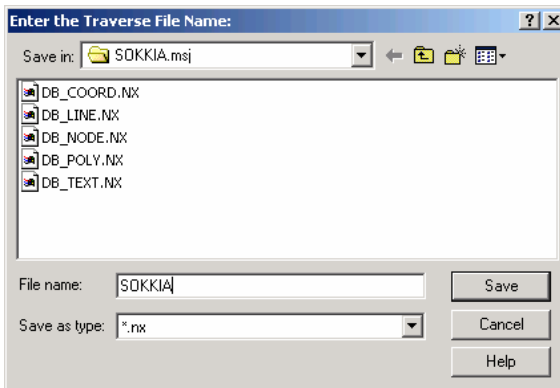

Fill in information about the job in the dialog box below and then pick the **OK** button.

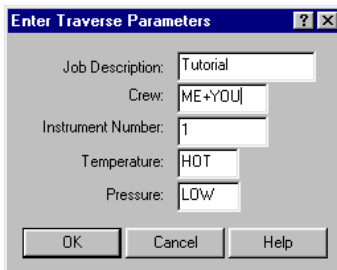

This collector file contains only coordinate information and therefore all the points are passed directly through to the database and screen. As the data points are loaded, you will see the data collector records scroll by in the text window, but because the view is not over the site, you don't see anything until the end when the program automatically does a zoom extents for us.

You will see this dialog box in the middle of the screen.

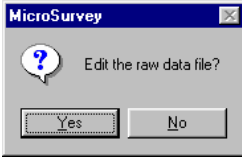

Pick on **NO**

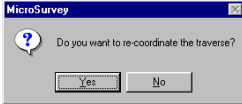

And **NO**.

Then when the Assistant menus come back on screen – hit **EXIT** on each one until they are removed from screen and you are left with just the job on screen.

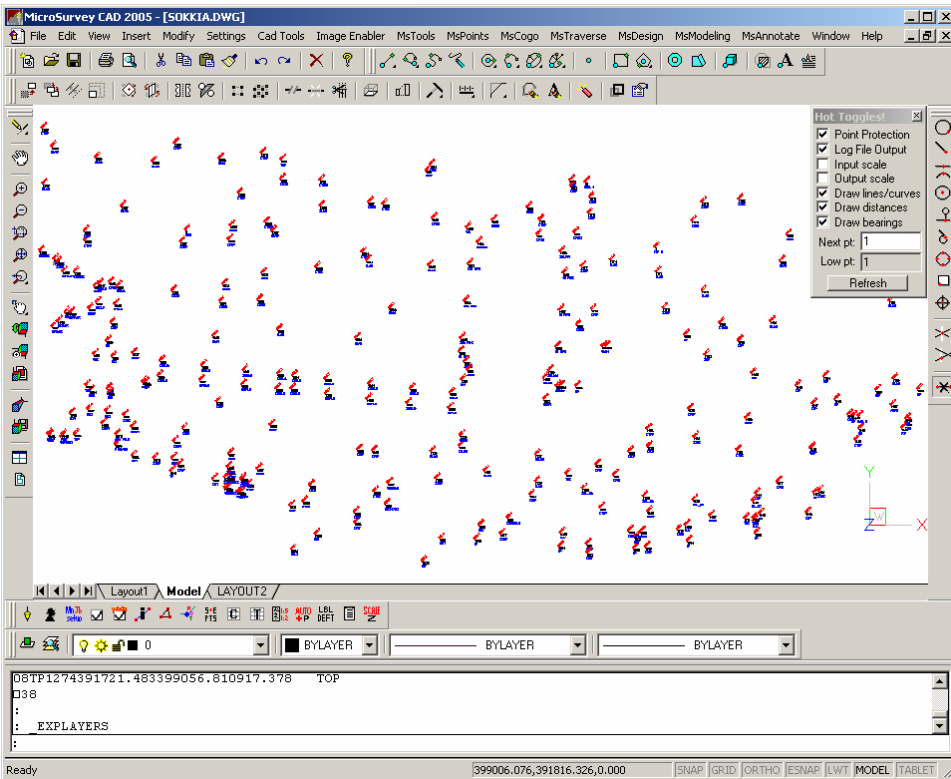

---

## Viewing the Drawing

(This step of the tutorial is to help show the points in the job in a view that will help you understand the program. This entire step is not required when doing your own jobs later)

You will see all of the labeled points from the job. If you zoom in on a couple of points, they would look like this.

936.9  
.1268  
ZTOP

933.7  
.1265  
TREE

(The zoom commands are found on the left side of the screen)



The annotation (text) is drawn at the current elevation (usually zero), but the points are drawn at their actual 3D elevation. You can see this by looking at your drawing from an oblique view.

Let's set our drawing to an oblique view. Run the Preset Viewpoints... command, found in the **View drop-down menu**. You will see this dialog:

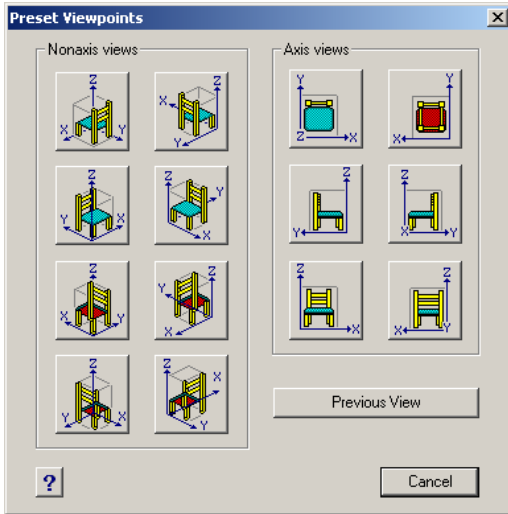

Now press this button (this is the ISO View SW button):

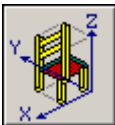

Then Press the OK button.

You will see from this oblique view that the points are at their elevation towards the top of the screen and the annotation is at an elevation of zero.



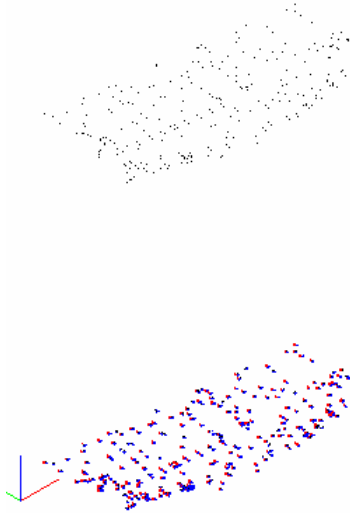

Now pick the **Top View (Plan View)** icon button found in the 3D View... command, to return to a normal view.

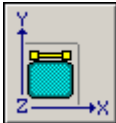

### Line Connection – Z-coding

We are going to connect points sharing the same description with 3D break lines, so let's create a layer on which to place them. Select the layers icon in the bottom left portion of the screen, as shown here.



Make a new layer called "lines" and make it current as follows:

The window opens to the Layers table. Pick the New button at the top left end of the toolbar, and type in **LINES**. Pick the small blue check mark to make the LINES layer the current layer. In this case I set the lines layer color to black (255) by picking the small box to the right of the layer name. Close the IntelliCAD Explorer window.

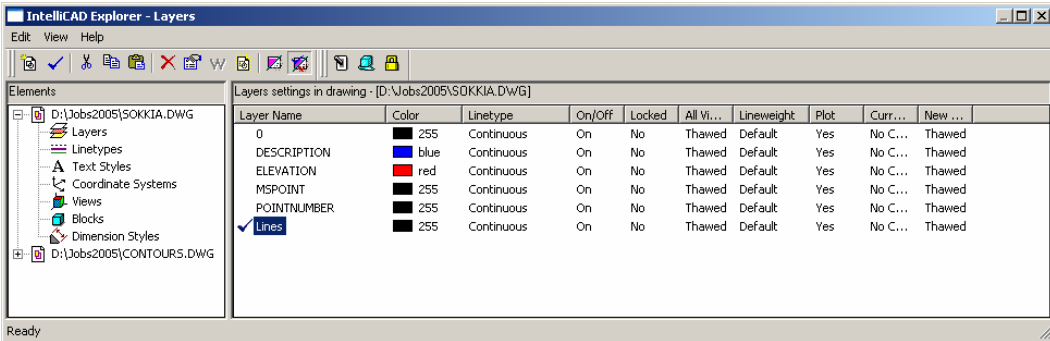

From the MsTraverse pulldown menu, select **AutoMAP System** → **Connect Points by X Y Z**, and you will see

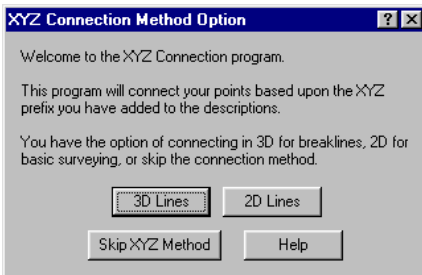

We will be using these as break lines for our topographic surface, so pick the **3D Lines** button.

You will see some linework being drawn on screen and then you will see the following dialog box.

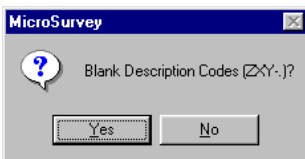

The data collector file in this example uses Z coding to allow for fast automatic connection of points with lines. Normally, you would blank the description codes to remove the leading Z character, but for this demo, answer **NO** to blank description codes so you can see them.

Now your screen should look like this. The lines you see are in 3D, just like the points that were used to create the lines.

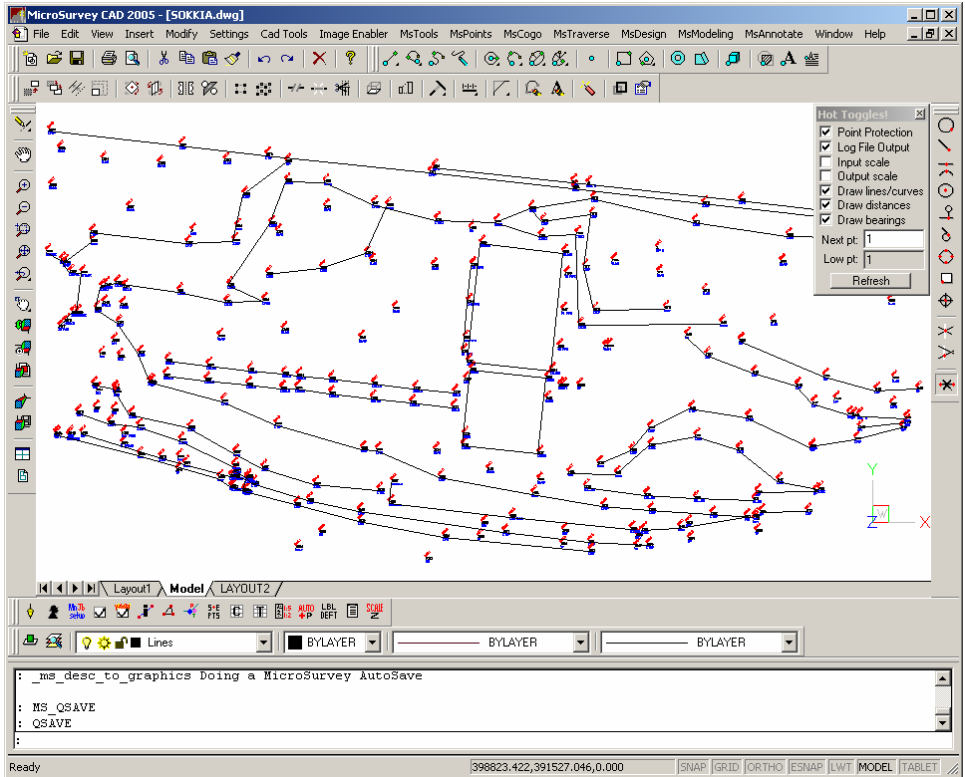

## Create Surfaces

Now you have points and break lines, which is all you need for a topo map and surface.

We will extract the data from which to make our map by using the Data Extraction filters in the Modeling routines. This allows us to be very specific on what we are using to create our surface. You do not always need to use the filters but doing so allows you full control.

Go to the MsModeling pulldown menu and pick on **Configuration Settings**.

This dialog will appear:

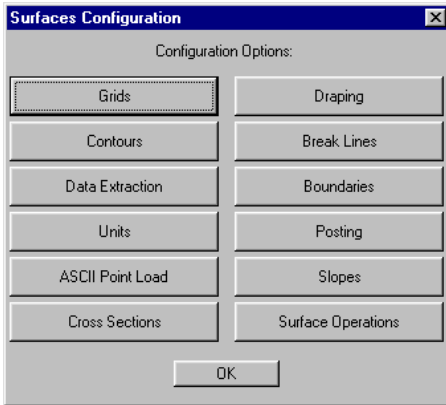

Pick on the **Data Extraction** button and this dialog box comes up.

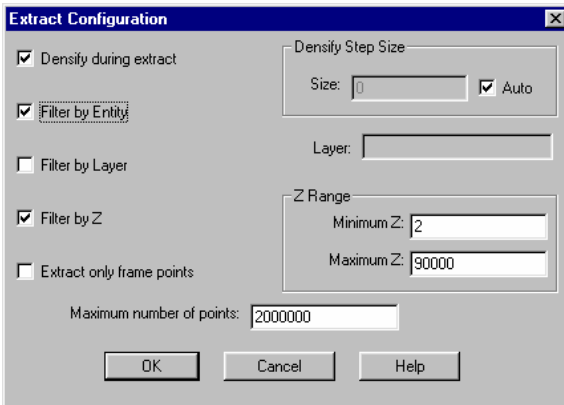

Pick on the **Filter by Entity** button and then pick **OK** to continue, and **OK** again to exit the previous dialog.

Next go to the MsModeling pulldown menu and select **Extract from Drawing → Extract to Surface**. You will see the dialog box shown here. Accept the surface name of **Ground** and pick the **OK** button to continue.

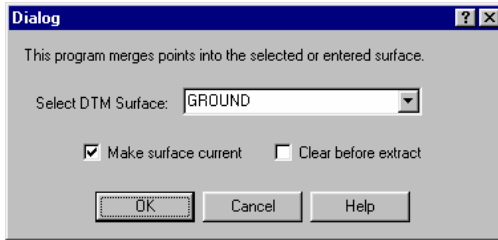

Now you will be asked what it is you are picking to create your surface. On this dialog pick **POINT** from the list – then pick the **SELECT** button and then the **OK** button to continue.

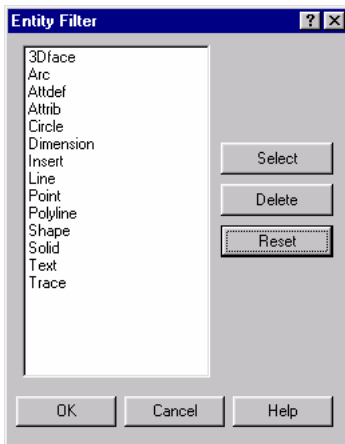

Next select the points, by windowing the entire drawing, or simply press **ENTER** and the routine will grab everything in the drawing automatically for you. Don't worry if you get the break lines too as we have told it to filter out just the points at this time.

264 points total in surface.

You have now placed all the points on the surface **Ground**. Now we need to do the same thing with the breaklines.

Pull down the MsModeling menu and select **Extract from Drawing** → **Extract Breaks**. This will show the following dialog box, similar to the one above.

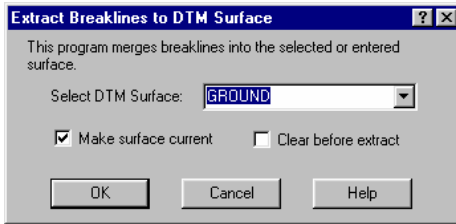

Pick **OK** to accept the surface name **Ground**. Both the points and breaklines must be on the same surface.

Now you will see the following dialog box.

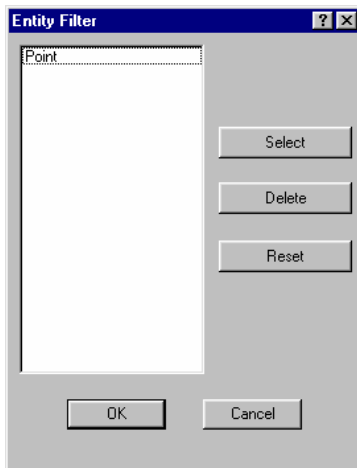

Pick on the **RESET** button and then pick on **LINE**, **POLYLINE** and **LW Polyline**, as shown below.

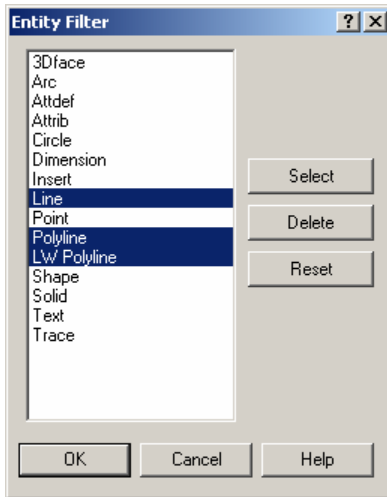

Then pick on the **SELECT** button. What you are doing is telling the routine that you no longer wish to pick points but now wish to pick lines and polylines to add them as breaklines to your surface. Then pick on the **OK** button to continue.

Now you can select the breaklines by making a window around the drawing, or by simply pressing **ENTER** to select everything on screen. Don't worry if you get the points too as the filter will only use the 3D lines and polylines it finds.

179 additional points added to current surface.

**Note:** The order is important here. Extract points first, then breaks. This puts the extracted data into a surface named what you decide. The default is GROUND. We don't see anything yet because we just created a surface in memory, but have not displayed it.

### **3D Viewing and Advanced Rendering**

Most of the time you would just create and draw contours at this point, but we will take a two-minute side trip to explore basic site visualization in 3D. To start with, we are going to create and draw a TIN (Triangulated Irregular Network) representing the topography by selecting **TIN** from the **MsModeling** menu -> **TIN Create/Edit** option, pressing return to select the **<GROUND>** surface and then answering **D** to Draw the surface

(rather than the temporary Show) and press return *twice* to draw it as a **polyface mesh** entity with invisibility as **NONE**. This is the 3D surface representing the points and breaks of the surface.

Here is what you should now see.

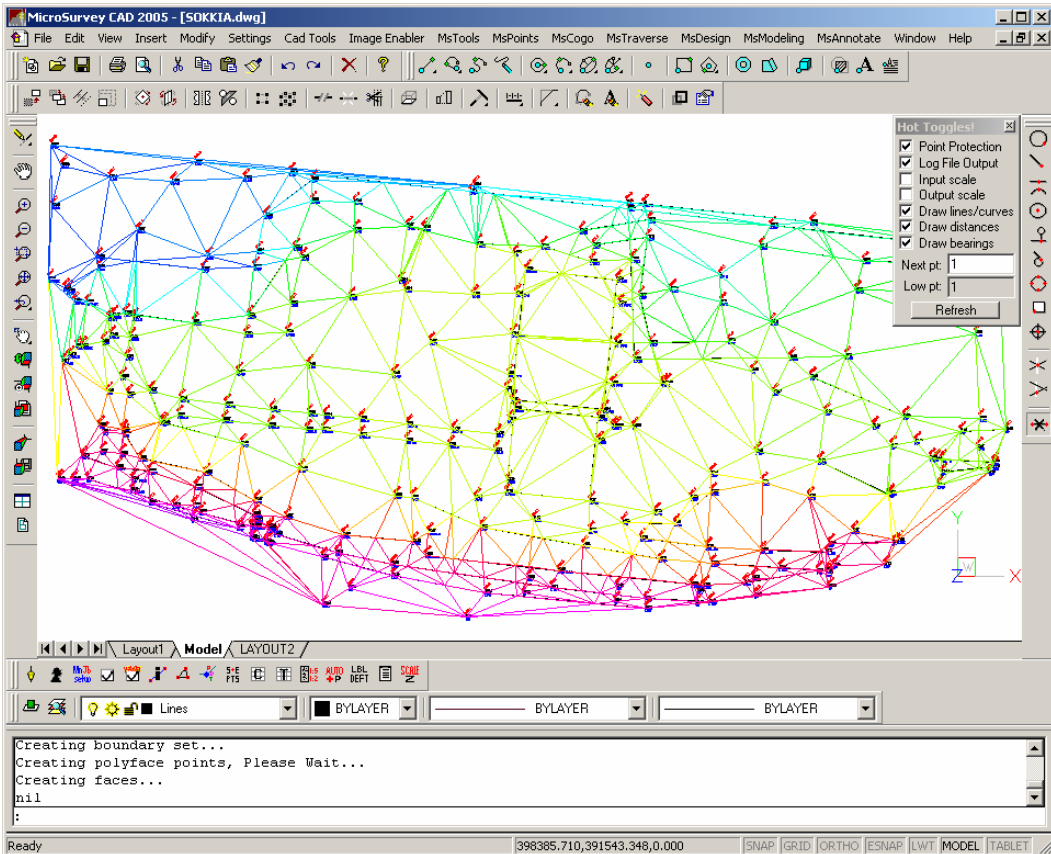

## Cleanup of screen

We will erase the TIN from the screen so we can see the rest of the job. We will use a shortcut to do this. Press an **E** (for erase) followed by **<enter>**, then when prompted to select objects, answer **L <enter>** to select the last object drawn, then press **<enter>** again. MicroSurvey has shortcuts called *selection sets* like Last and Previous that can speed your work.



---

(If the Tin does not erase then try again and pick one of the triangles while in the erase command)

Occasionally you may need to redraw the display in MicroSurvey to clean up artifacts from erasing entities.

Pick the redraw button on the left side menu to run the redraw command.



### **Quick Contours**

Contours may be generated by three different methods. To set the correct method for what you require we need to do 2 things. First we need to set the color map to what we require. Go to the **MsModeling pulldown menu → Color Options → Reset Color Map**.

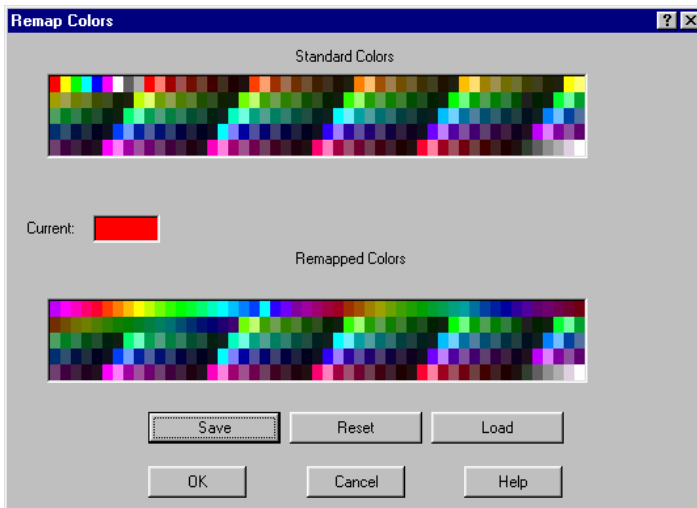

Pick on the **RESET** button and then the **OK** button.

What this is doing is setting the colors to standard CAD colors so you can set your pen widths for plotting easily.

Now we need to tell the routine which method to use to color the contours and to set the interval.

Go to the **MsModeling** pulldown menu → **Color Options** → **Contour Color Settings**

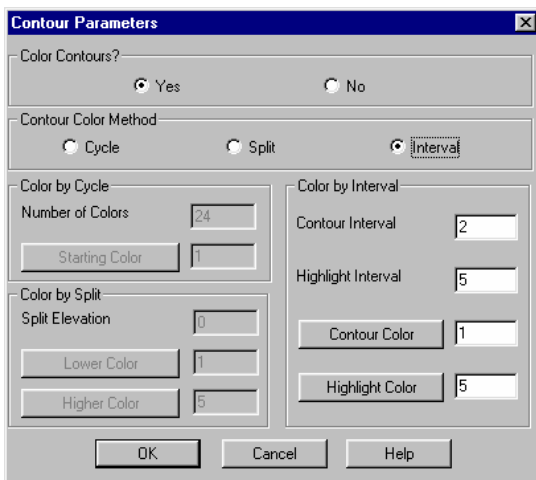

Set your defaults to match this dialog

We will draw our contours on their own layer. Make a new layer named contours and make it current, just like you did for the lines layer previously. Pick the Layer Management button. Pick the new button at the top left end of the Explorer toolbar. Type in **CONTOURS** in the edit box and press **Enter**. Highlight the **CONTOURS** layer and pick the blue check button to make it current. You can also double click on the layer in the Explorer to make it current. Close the Explorer.

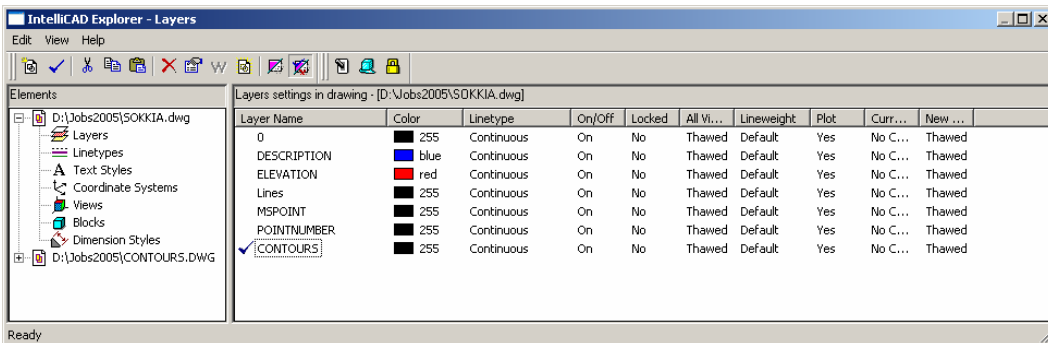

Select the **Contour** command from the **MsModeling** pulldown menu, press **<enter>** to accept the **<GROUND>** surface (the surface to which you extracted your points) and press **<enter>** to temporarily “show the contours”.

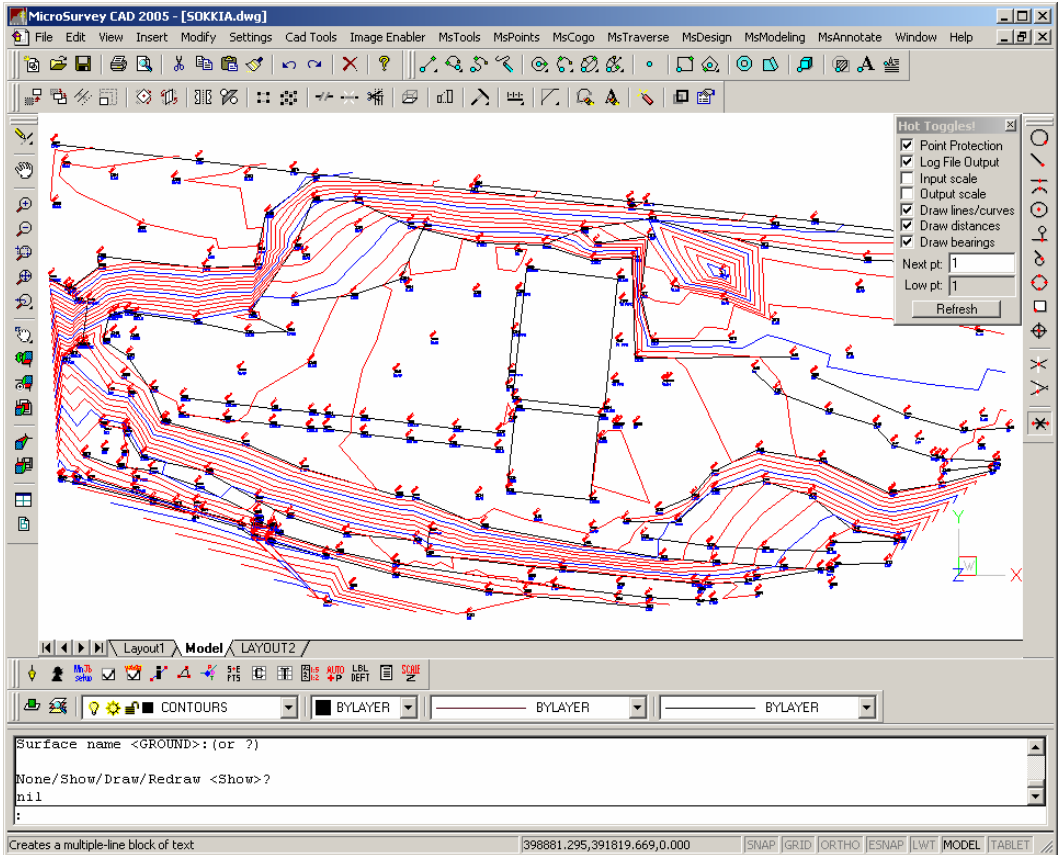

The contours are NOT yet part of the drawing. They are only in memory and displayed temporarily.

The contours are displayed temporarily until the next refresh of the screen, such as pan or zoom or redraw. If there was a problem with a bad elevation, you could fix it before drawing permanent contour lines.

### Setting up a Boundary

Most of the time in a topo survey you will take shots outside of the actual property lines for control, but you may only want to display contours within the property outline. We will do this by setting up and using a boundary. A boundary acts like a Trim line, cropping the contours so they do not pass over the polyline. We will add a boundary polyline, then draw and label contours for this site.

Draw a polyline similar in shape to the bold line shown below to use as a boundary. This line might represent a property line or an arbitrary trim line for the contours. (Your polyline will not be bold by default. We made this one bold so you could see it easily.)

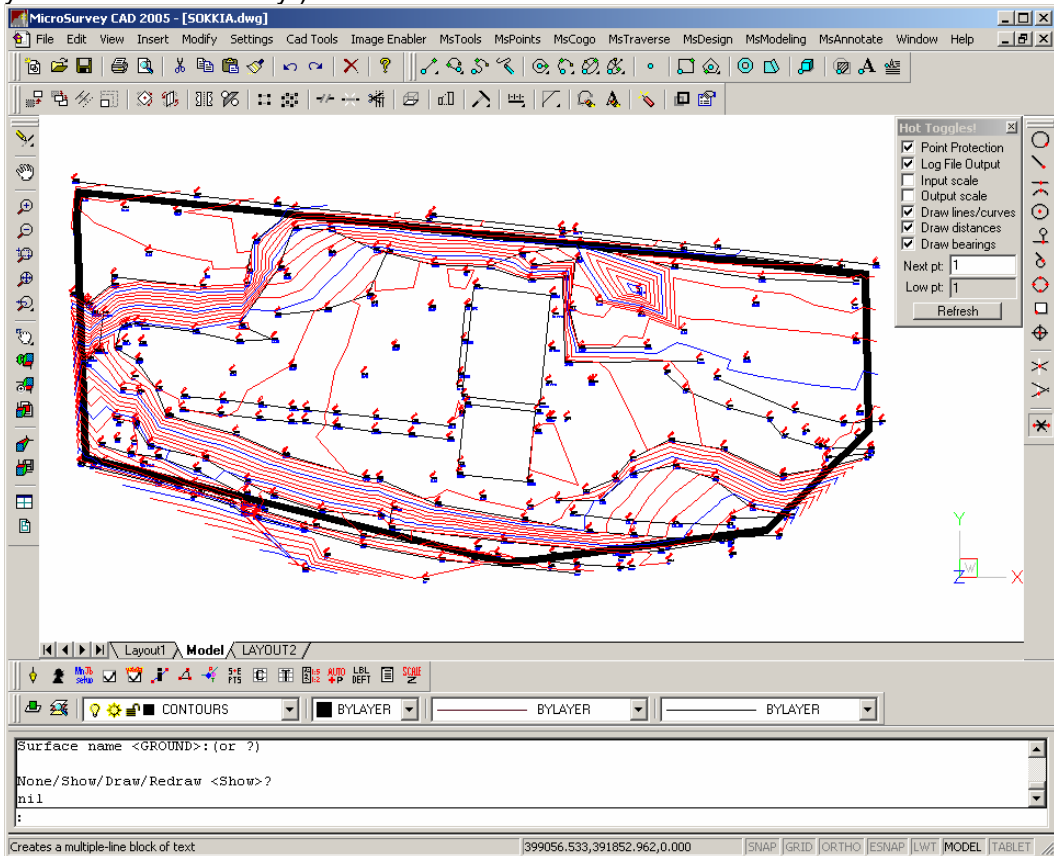

If you are unfamiliar with the polyline command, type **PL** then left click on each location where you would like a vertex, then finish by typing a **C** to close the polyline into a closed polygon suitable for a boundary. (See the MicroSurvey help for more information).

Select this polyline as a boundary, by running the **Boundary Options → Set Boundary** command from the **MsModeling pulldown menu** and selecting the polyline boundary you just created. Press **<enter>** to complete the selection. Now the contours will be limited to within this boundary, when we run the contour

---

command again to draw them. (See the help file for more on boundaries, including nested boundaries)

Refresh the screen by picking on the redraw button on the left side menu.



The contours disappear because they were displayed temporarily with the show command. Now we will draw them permanently, honoring our new boundary.

### **Final Contours**

Select **Contour** from the **MsModeling pulldown menu**, press **<enter>** to accept the **<GROUND>** surface (the surface to which you extracted your points) and type **D** at the command line, and **NO** to the Close All prompt.

You will now see the following on screen.

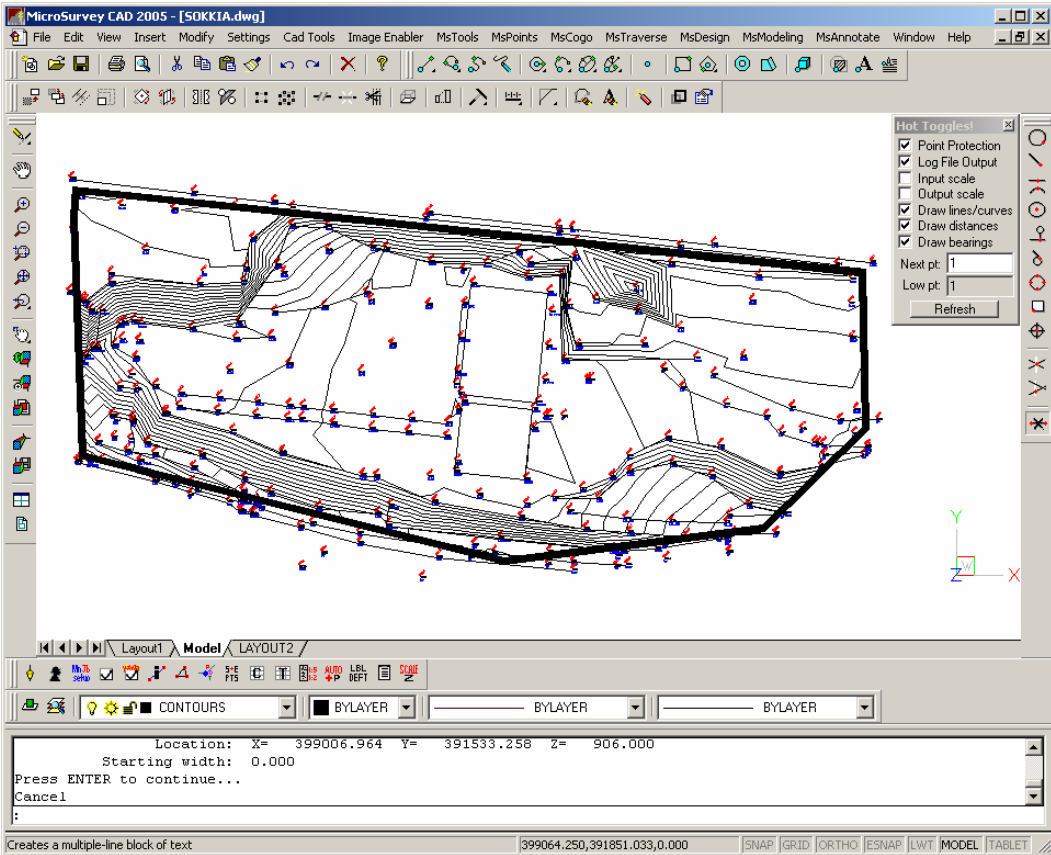

The drawing is getting cluttered, so let's turn off all layers except the **Contours** layer. Go to the **MsTools** → **Layer Control** → **Isolate**. Then pick on one of the contours and press **<enter>**.

What you are left with is this:

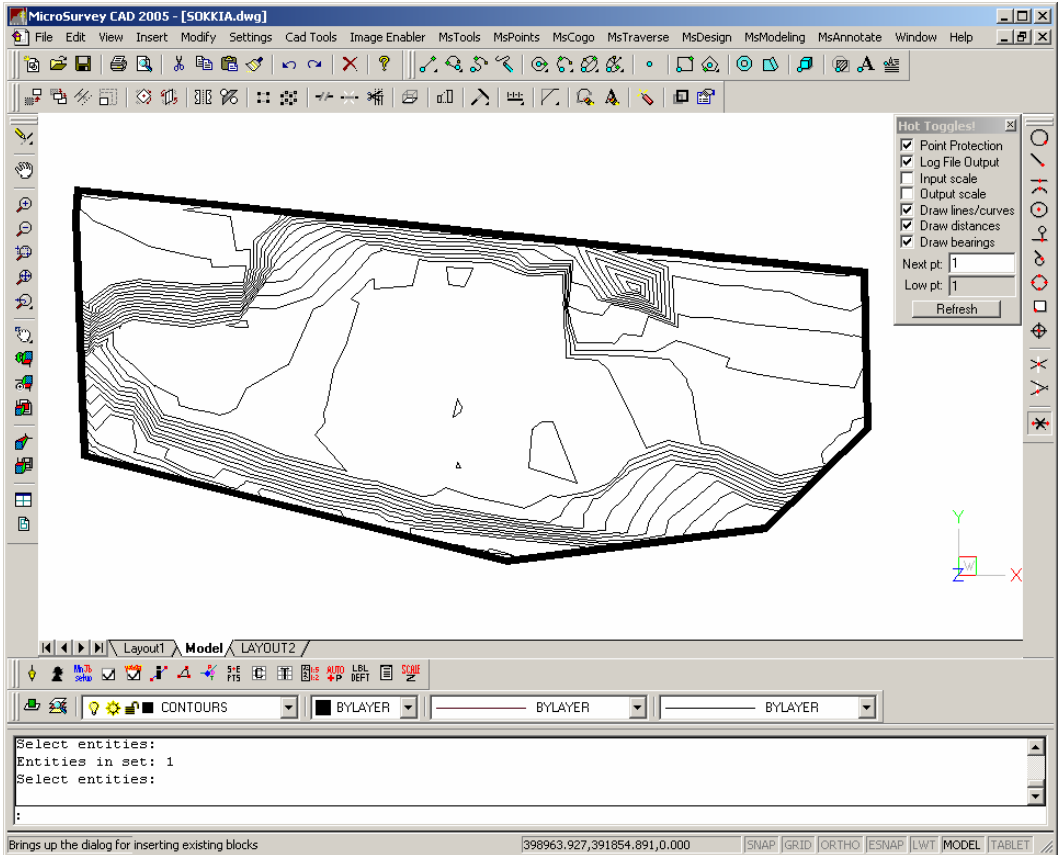

Erase the polyline we drew for the boundary, as it is no longer needed, because the contours are now drawn and trimmed.

Type **E** enter and pick the boundary polyline, then press enter.

## **Labeling Contours and Saving Your Work**

Zoom in on the steep slope in the NW part of the site. To zoom window, press **Z** **<enter>** **W** **<enter>** and specify two corners. (Or, you can use the  button on the left side of the screen to zoom window.)

The black box in the image below shows you where to pick for the Zoom Window command.



Select **Annotate → Label Contours** from the **MsModeling** pulldown menu. You will be prompted for a text height. You may specify one graphically by clicking on the screen to indicate the text height, or enter a number. In this case a height of 2.5 was used.

Next you will be repeatedly prompted for label locations.

Click on contours where you would like labels, and the labels will be placed and the contours trimmed as needed.

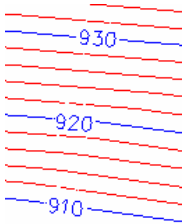

**NOTE:** To label many contours in a straight row, draw a polyline across the contours where you wish to have them labeled. Then run the Label Contours command again – this time after giving the text height, pick the CONTROL button found on the option bar. Then by following the prompts, select all the contours to label (be sure to not pick the polyline to be used as control lines to label along). After picking all the contours to be labeled – press enter. Then pick the control polyline and you should see the labels start to draw on the contour lines exactly where the control polyline intersected them. The Control polyline is automatically removed from the drawing.



---

Example:

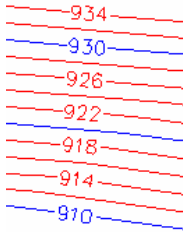

Now lets Zoom to the Extents of the drawing to see everything on screen.

Type **Z <enter>** then **E <enter>**, or pick the  button.

Now we are going to Smooth the contours. Go to the **MsModeling pulldown menu → Annotate → Smooth Contours**.

Either pick the contours to smooth or simply press **<enter>** to select them all automatically.

After smoothing your diagram should look like this.



Now save your job by picking the save command on the file menu. You also need to save the surface by going to the **MsModeling pulldown menu → Surface Operations**. Pick the surface name on the left side of the dialog and then select the **Write QSB button**.

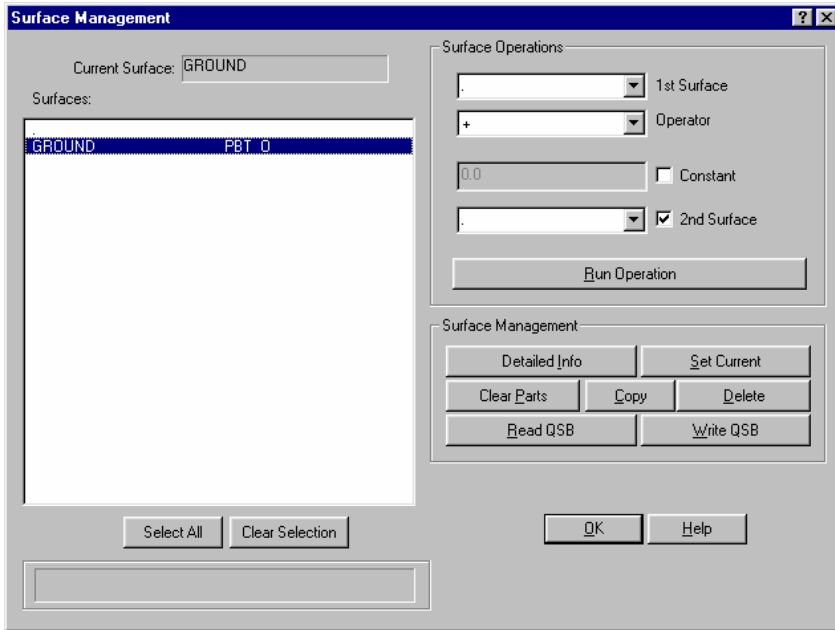

Set the folder to Jobs2005, the same location we started the job. Do not place the file in the SOKKIA.MSJ folder. Enter the name SOKKIA and press the **SAVE** button.

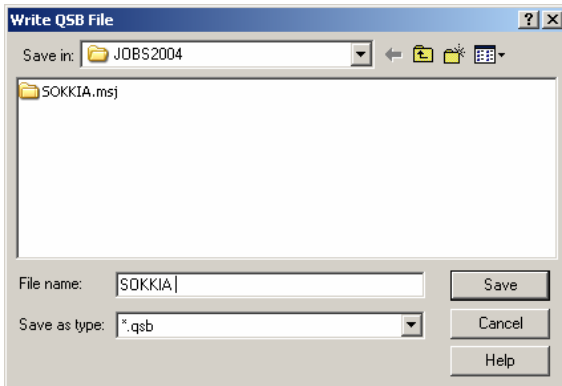

Pick the **OK** button on the previous dialog to continue

Your surface is now saved along with the drawing and the database.

You may now exit the program via the **File pulldown menu**.

---

## Simple Traverse Tutorial

Because of the size and complexity of this tutorial we have broken it down into 9 smaller steps to make it easier for you to follow.

Step 1) Starting the Job

Step 2) Setting the Defaults

Step 3) Manual Traverse Entry

Step 4) Start Entering Shots

Step 5) List of Data to Enter

Step 6) Coordinating the Traverse

Step 7) Computing Closure

Step 8) Adjust Angles + Compass Balance

Step 9) Listing the Traverse

## Starting the Job

In this cookbook-style tutorial we will enter a simple 2D traverse around a farm. This traverse was done to locate the corners of the boundary, and to locate a building on the farm.

Here is what your finished product will look like.

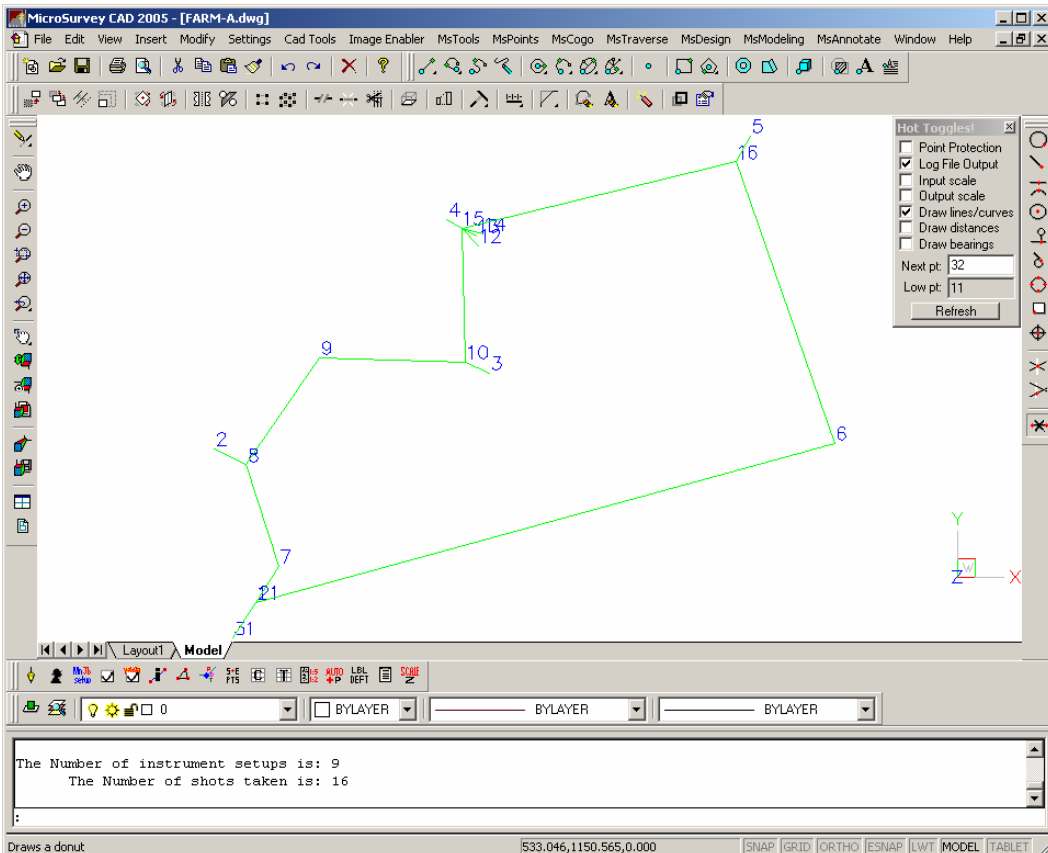

### **Overview:**

The surveyor began by setting up on one corner of the farm property and assigning a coordinate of North = 1000, East = 1000, Elev = 0, Point number = 1. He then backsighted an iron bar with a known direction of 214 degrees 12 minutes, 15 seconds. Since he could not directly set up on all the bars on the property because of rocks, hedges, and fences, he traversed around the property

---

taking side shots into the corners. On the traverse, he also located three corners of a shed.

### To Begin:

To begin, start a new drawing by running the New ... command, found under the **File drop-down menu**.

Pick the New button on the Project Manager, and fill in the name of the job and call it **FARM-A**. Then pick **Save** to continue.

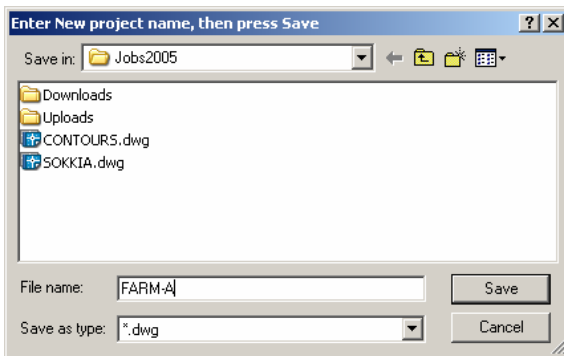

Next you will see the General Configuration Options dialog box.

Set the scale and other settings as shown below.

### Setting the Defaults

Once the new job opens you will be asked to fill out the following as shown, setting the units to **Feet, Azimuths** and the scale to **1=500'**. Do not pick the OK button yet!

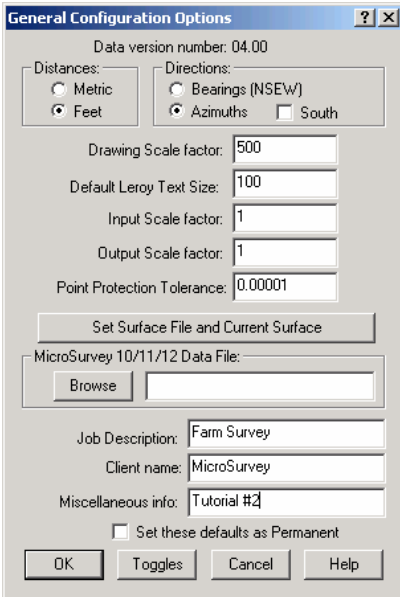

## Main Job Defaults dialog box

From the bottom of this dialog box, select the **Toggles** button. Set the System Toggles as shown in the 3 Figures below.

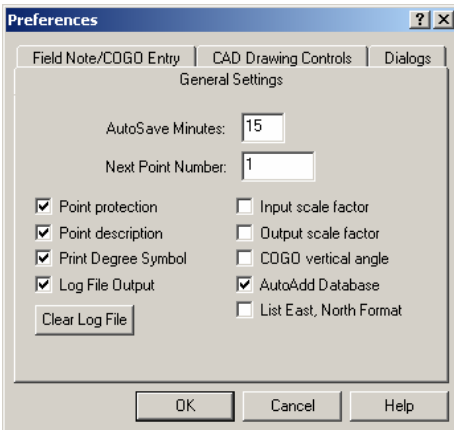

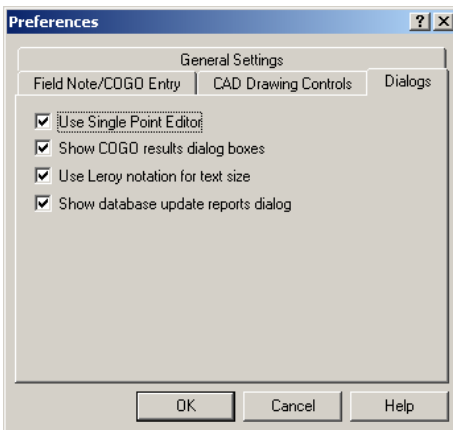
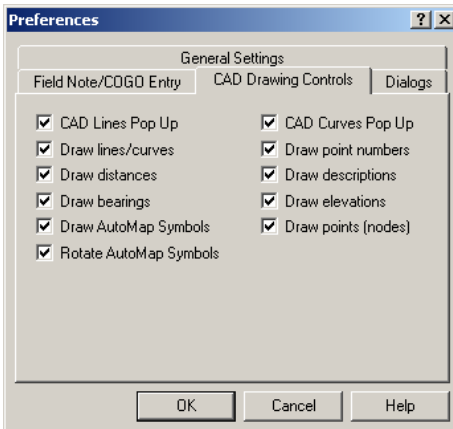
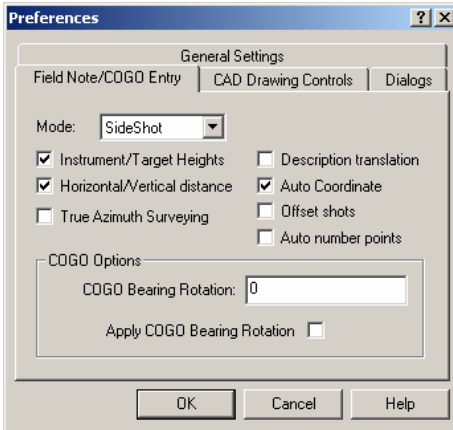

## System Toggles dialog boxes

Now press the **OK** button to return to the previous dialog – and press the **OK** button again to continue.

## Manual Traverse Entry

This is what your screen should now look like: (if the Assistant is not on screen then pick the Assistant button from the main MicroSurvey CAD toolbar near the bottom of the screen, or type Assistant at the command line and press Enter.

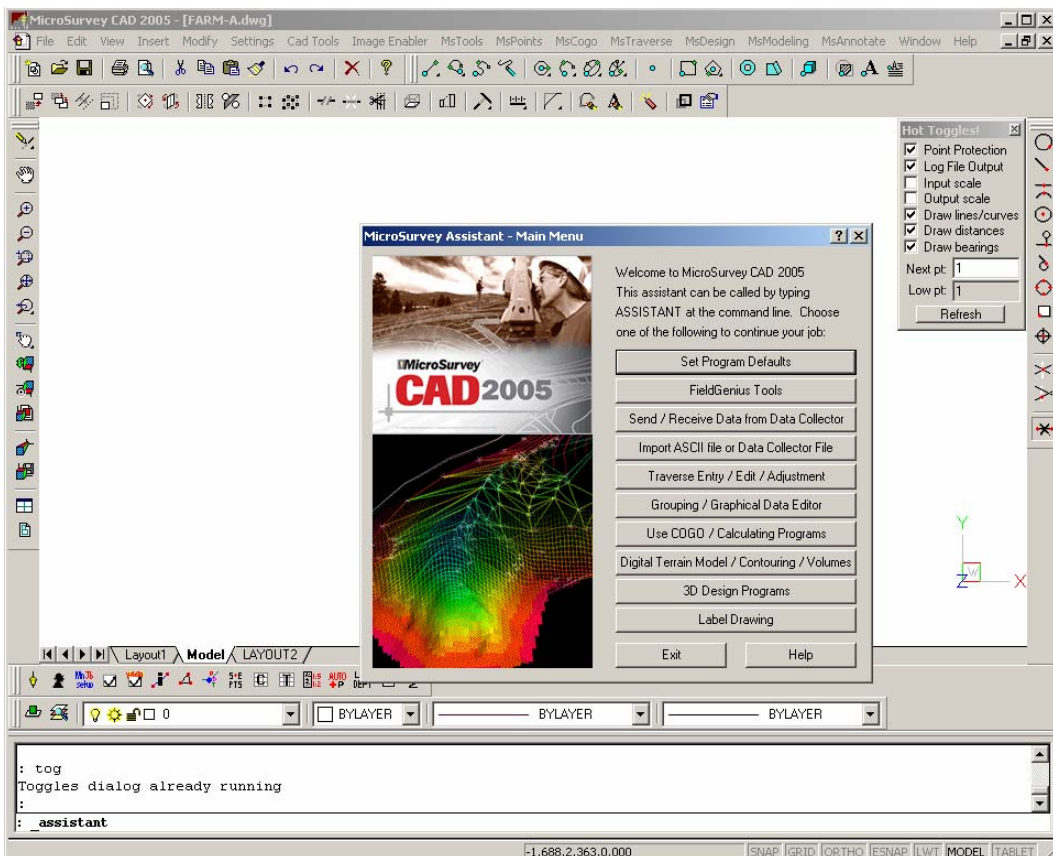

Next, from the Assistant, pick the **Traverse Entry / Edit / Adjustment** button:



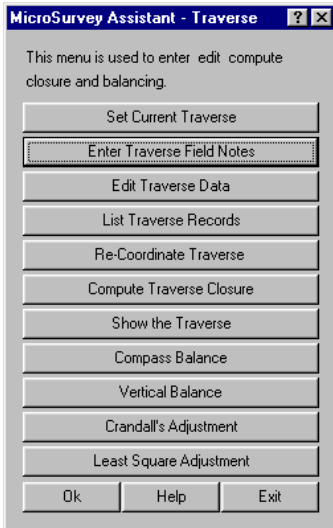

Pick the **Enter Traverse Field Notes** button.

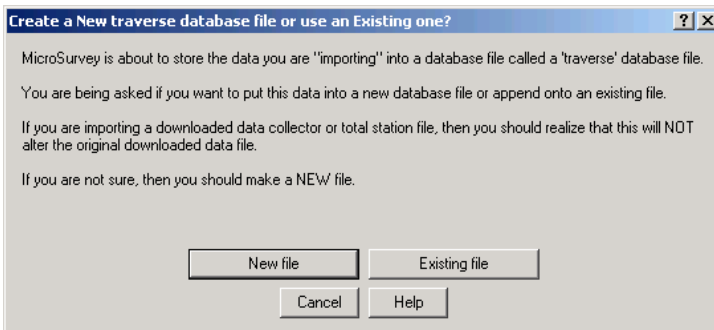

Pick on the **New Traverse** button

MicroSurvey will respond with a dialog box for you to enter your job name. Enter **FARM-A** in the dialog box as shown below:

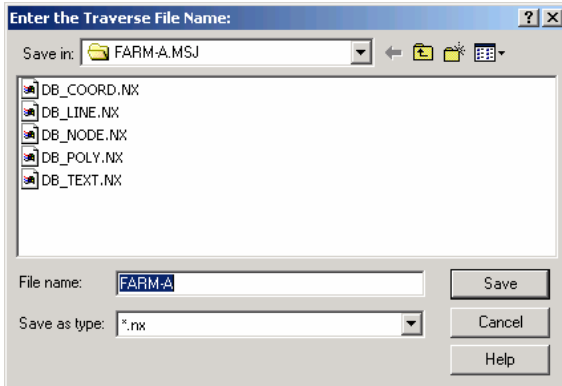

Pick the **SAVE** button to continue. You will be prompted with a dialog box to fill out with information about the traverse:

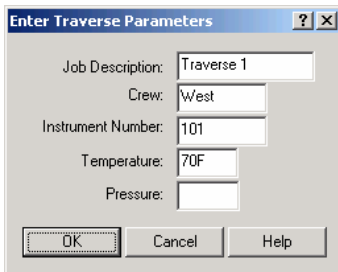

Pick OK and then you will be asked:

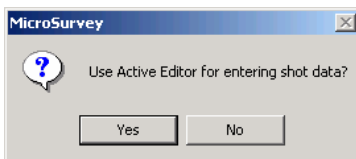

Answer this **NO**, as we will use the normal dialog boxes to enter the traverse.

Answer **Yes** to the following dialog, so we start entering data with dialog boxes:

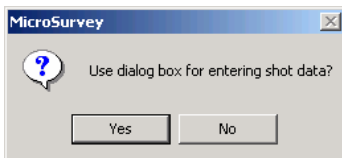

We will work with the dialog boxes so answer **YES** to this.

Now you are asked to enter the information for your first setup station, with appropriate backsight information.

We have a Setup Point of 1 with coordinates of N=1000, E=1000, Z=0 so enter the **Setup Point Number** as 1 and then pick the **EDIT** button to the right of the point number. Fill in the new Dialog as shown below and pick Ok to finish.

NOTE: Use the TAB key to move between fields:

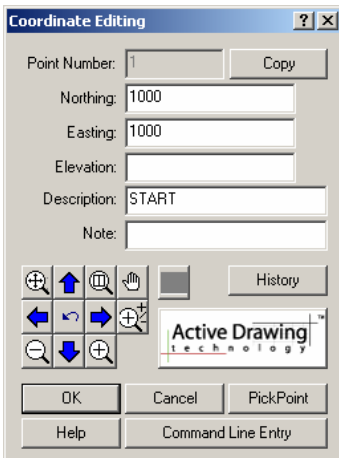

We have a backsight azimuth of 214 degrees 12 minutes 50 seconds from where we set up, so a backsight azimuth of **214.1250** in the edit box, as shown below: (Leave the other entries as shown)

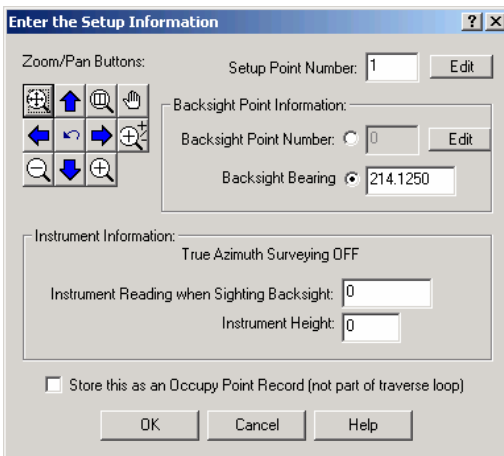

---

Now pick the **OK** button to continue.

The program will go immediately into the data entry mode.

### **Start Entering Shots**

Enter the first shot information into the dialog box as shown below.

Enter Correct Data for Shot

Setup pt.: 1 Bksite pt.: 0

Horizontal Angle: 177.0930

Horizontal Distance: 98.44

Vertical Distance: 0.

Target Height: 0.

Point number: 7

Description:

Parallel Offset: 0.

Perpendicular Offset: 0.

Toggles

OK Next setup Help

(If the above dialog asks for Vertical Angles and Slope Distances instead of the Horizontal Distance and Vertical Distance, then you did not set the system toggles correctly. Exit out of the Traverse Entry Mode, change the Toggles to match what was given earlier and start the traverse entry over again)

Pick the **OK** button or press **<enter>** to continue

The program will compute the coordinate and display the information in a dialog box:

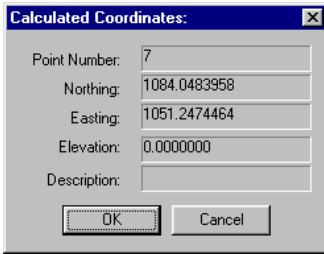

Pick **OK** to accept this information.

MicroSurvey allows you to switch back and forth between entering traverse legs and entering side shots at any time. We will enter the traverse and side shots together.

*Rather than fill up this entire manual with screen shots showing the information to type into this tutorial, we are going to list the shots and setup information to enter. (To start a new setup, just pick **Next Setup** or press **Esc** at the **Enter Correct Data For Shot** dialog box. The program will return to the setup dialog box.)*

At this point you will be asked for the next side shot to be entered from the same setup. We have no more shots from this setup so we need to traverse forward to the last shot we just finished entering.

Pick the **Next Setup** button or press the **Esc** key on your keyboard to return to the **Enter the Setup Information** dialog box.

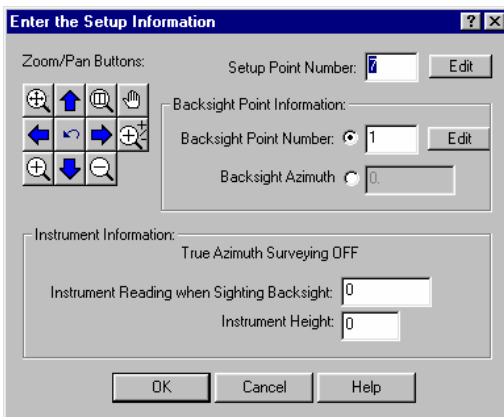

---

## List of Data to Enter

You will notice it has automatically updated the **setup point number** and the **backsight point number** with the following data:

Set up on Point **7** and backsight **1**.  
Pick the **OK** button to accept these values.

Now you can enter the next Shot

Horizontal Angle :**131.0316**  
Horizontal Distance :**248.31**  
Vertical Distance :**0**  
Point Number :**8**  
Description :

Pick the **OK** button to continue. Press the **OK** button to accept the calculated coordinate.

Next pick the **Next Setup** button to go back to the setup dialog box.

Set up on Point **8** and backsight **7**.  
Pick the **OK** button to accept these values.

Enter the following Shot:

Horizontal Angle :**134.2554**  
Horizontal Distance :**83.92**  
Vertical Distance :**0**  
Point Number :**2**  
Description :

Pick the **OK** button to continue. Press the **OK** button to accept the calculated coordinate.

Do **NOT** Pick the **Next Setup** button.

Enter the following Shot:

Horizontal Angle :**231.5652**  
Horizontal Distance :**302.5**  
Vertical Distance : **0**  
Point Number :**9**

---

Description :

Pick the **OK** button to continue. Press the **OK** button to accept the calculated coordinate.

Next pick the **Next Setup** button to go back to the setup dialog box.

Setup on Point **9** and backsight **8**.

Pick the **OK** button to accept these values.

Enter the following Shot:

Horizontal Angle :**237.1721**

Horizontal Distance :**341.71**

Vertical Distance : **0**

Point Number :**10**

Description :

Pick the **OK** button to continue. Press the **OK** button to accept the calculated coordinate.

Next pick the **Next Setup** button to go back to the setup dialog box.

Setup on Point **10** and backsight **9**.

Pick the **OK** button to accept these values.

Enter the following Shot:

Horizontal Angle :**203.2344**

Horizontal Distance :**60.18**

Vertical Distance : **0**

Point Number :**3**

Description :

Pick the **OK** button to continue. Press the **OK** button to accept the calculated coordinate.

Do **NOT** Pick the **Next Setup** button.

Enter the following Shot:

Horizontal Angle :**86.3210**

Horizontal Distance :**312.35**

Vertical Distance : **0**

---

Point Number :**15**  
Description :

Pick the **OK** button to continue. Press the **OK** button to accept the calculated coordinate.

Next pick the **Next Setup** button to go back to the setup dialog box.

Setup on Point **15** and backsight **10**.  
Pick the **OK** button to accept these values.

Enter the following shot:

Horizontal Angle :**123.1746**  
Horizontal Distance :**40.19**  
Vertical Distance : **0**  
Point Number : **4**  
Description :

Pick the **OK** button to continue. Press the **OK** button to accept the calculated coordinate.

Do **NOT** Pick the **Next Setup** button.

Enter the following Shot:

Horizontal Angle :**317.1045**  
Horizontal Distance :**56.92**  
Vertical Distance : **0**  
Point Number :**12**  
Description :

Pick the **OK** button to continue. Press the **OK** button to accept the calculated coordinate.

Do **NOT** Pick the **Next Setup** button.

Enter the following Shot:

Horizontal Angle :**300.1321**  
Horizontal Distance :**38.54**  
Vertical Distance : **0**  
Point Number :**13**  
Description :



---

Pick the **OK** button to continue. Press the **OK** button to accept the calculated coordinate.

Do **NOT** Pick the **Next Setup** button.

Enter the following Shot:

Horizontal Angle :**287.3017**

Horizontal Distance :**51.68**

Vertical Distance : **0**

Point Number :**14**

Description :

Pick the **OK** button to continue. Press the **OK** button to accept the calculated coordinate.

Do **NOT** Pick the **Next Setup** button.

Enter the following Shot:

Horizontal Angle :**258.1506**

Horizontal Distance :**658.78**

Vertical Distance : **0**

Point Number :**16**

Description :

Pick the **OK** button to continue. Press the **OK** button to accept the calculated coordinate.

Next pick the **Next Setup** button to go back to the setup dialog box.

Set up on Point **16** and backsight **15**.

Pick the **OK** button to accept these values.

Enter the following Shot:

Horizontal Angle :**131.4731**

Horizontal Distance :**69.42**

Vertical Distance : **0**

Point Number :**5**

Description :

---

Pick the **OK** button to continue. Press the **OK** button to accept the calculated coordinate.

Do **NOT** Pick the **Next Setup** button.

Enter the following Shot:

Point Number : **6**  
Horizontal Angle :**264.1350**  
Horizontal Distance :**695.37**  
Vertical Distance : **0**  
Description :

Pick the **OK** button to continue. Press the **OK** button to accept the calculated coordinate.

Next pick the **Next Setup** button to go back to the setup dialog box.

Setup on Point **6** and backsight **16**, and  
Pick the **OK** button to accept these values.

Enter the following Shot that is back to the original setup point:

Horizontal Angle :**273.5655**  
Horizontal Distance :**1399.37**  
Vertical Distance : **0**  
Point Number :**21**  
Description :

Pick the **OK** button to continue. Press the **OK** button to accept the calculated coordinate.

Next pick the **Next Setup** button to go back to the setup dialog box.

Setup on Point **21** and backsight **6**.  
Pick the **OK** button to accept these values.

Now take the final shot to the closing foresight point. This is the starting backsight point.

Horizontal Angle :**139.3500**  
Horizontal Distance :**100**

---

Vertical Distance : **0**  
Point Number :**31**  
Description :

Pick the **OK** button to continue. Press the **OK** button to accept the calculated coordinate.

Next pick the **Next Setup** button to go back to the setup dialog box.

This concludes the survey data entry. You can exit by picking the **CANCEL** button.

### Coordinating the Traverse

You should be back to the assistant menu shown below:

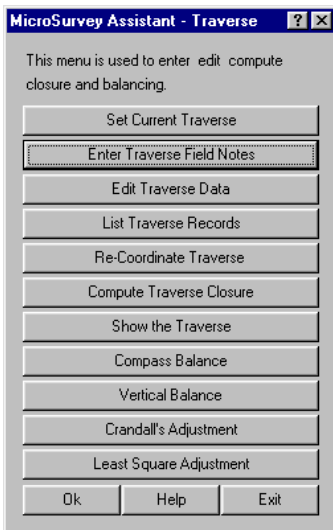

We are going to Edit your Traverse Data to ensure you have not made any mistakes in entry

Pick on the **Edit Traverse Data** button.

You will see the following Summary:

Active Drawing Technology™ - [Traverse Editor : FARM-AA]

File Edit Window Format Help

Job Desc	Crew	Inst Num	Temp	Pressure	Start Date			
Traverse 1	West	101	70F		10/12/01			
Station	BS Pt	BS Azm	BS Read	Inst Ht				
1		214°12'50"	0°00'00"	0.00				
Shot Pt	Trgt Ht	Hz Ang	Vt Ang	Slp Dist	Desc	North	East	Elev
7	0.00	177°09'30"	90°00'00"	98.44		1084.048	1051.247	-0.000
Station	BS Pt	BS Azm	BS Read	Inst Ht				
7	1		0°00'00"	0.00				
Shot Pt	Trgt Ht	Hz Ang	Vt Ang	Slp Dist	Desc	North	East	Elev
8	0.00	131°03'16"	90°00'00"	248.31		1320.770	976.276	-0.000
Station	BS Pt	BS Azm	BS Read	Inst Ht				
8	7		0°00'00"	0.00				
Shot Pt	Trgt Ht	Hz Ang	Vt Ang	Slp Dist	Desc	North	East	Elev
2	0.00	134°25'54"	90°00'00"	83.92		1358.684	901.409	-0.000
9	0.00	231°56'52"	90°00'00"	302.50		1570.443	1147.067	-0.000
Station	BS Pt	BS Azm	BS Read	Inst Ht				
9	8		0°00'00"	0.00				
Shot Pt	Trgt Ht	Hz Ang	Vt Ang	Slp Dist	Desc	North	East	Elev
10	0.00	237°17'21"	90°00'00"	341.71		1560.523	1486.633	-0.000
Station	BS Pt	BS Azm	BS Read	Inst Ht				
10	9		0°00'00"	0.00				
Shot Pt	Trgt Ht	Hz Ang	Vt Ang	Slp Dist	Desc	North	East	Elev
3	0.00	203°23'44"	90°00'00"	60.18		1535.033	1543.149	-0.000
15	0.00	86°32'10"	90°00'00"	312.35		1872.719	1478.821	-0.000
Station	BS Pt	BS Azm	BS Read	Inst Ht				
15	10		0°00'00"	0.00				
Shot Pt	Trgt Ht	Hz Ang	Vt Ang	Slp Dist	Desc	North	East	Elev
4	0.00	123°17'46"	90°00'00"	40.19		1893.715	1444.551	-0.000
15	0.00	247°04'52"	90°00'00"	25.00		1893.207	1243.000	-0.000

**Close the Assistant dialog that appeared on top of the window.**

Scroll down using the bar on the right to see the rest of the listing as shown below:

Shot Pt	Trgt Ht	Hz Ang	Vt Ang	Slp Dist	Desc	North	East	Elev
10	0.00	237°17'21"	90°00'00"	341.71		1560.523	1488.633	-0.000
Station		BS Pt	BS Azm	BS Read	Inst Ht			
10	9		0°00'00"	0.00				
Shot Pt	Trgt Ht	Hz Ang	Vt Ang	Slp Dist	Desc	North	East	Elev
3	0.00	203°23'44"	90°00'00"	60.18		1535.033	1543.149	-0.000
15	0.00	86°32'10"	90°00'00"	312.35		1872.719	1478.821	-0.000
Station		BS Pt	BS Azm	BS Read	Inst Ht			
15	10		0°00'00"	0.00				
Shot Pt	Trgt Ht	Hz Ang	Vt Ang	Slp Dist	Desc	North	East	Elev
4	0.00	123°17'46"	90°00'00"	40.19		1893.715	1444.551	-0.000
12	0.00	317°10'45"	90°00'00"	56.92		1832.205	1518.802	-0.000
13	0.00	300°13'21"	90°00'00"	38.54		1854.375	1512.715	-0.000
14	0.00	287°30'17"	90°00'00"	51.68		1858.730	1528.571	-0.000
16	0.00	258°15'06"	90°00'00"	658.78		2027.051	2119.268	-0.000
Station		BS Pt	BS Azm	BS Read	Inst Ht			
16	15		0°00'00"	0.00				
Shot Pt	Trgt Ht	Hz Ang	Vt Ang	Slp Dist	Desc	North	East	Elev
5	0.00	131°47'31"	90°00'00"	69.42		2088.206	2152.119	-0.000
6	0.00	264°13'50"	90°00'00"	695.37		1370.833	2349.304	-0.000
Station		BS Pt	BS Azm	BS Read	Inst Ht			
6	16		0°00'00"	0.00				
Shot Pt	Trgt Ht	Hz Ang	Vt Ang	Slp Dist	Desc	North	East	Elev
21	0.00	273°56'55"	90°00'00"	1399.37		999.941	999.980	-0.000
Station		BS Pt	BS Azm	BS Read	Inst Ht			
21	6		0°00'00"	0.00				
Shot Pt	Trgt Ht	Hz Ang	Vt Ang	Slp Dist	Desc	North	East	Elev
31	0.00	139°35'00"	90°00'00"	100.00		917.247	943.752	-0.000

(If you do have errors then you can edit the entry and make the correction now.)

**Select Re-coordinate Traverse from the Edit Menu on the Active Drawing Editor. Or you can type Ctrl-R if the editor window is current.**

You will be given the option of creating a Re-coordination Report or Log. Accept the defaults as shown:

Recoordination Report (Log)	
Multiple Shots Option	
<input checked="" type="radio"/> Let me choose the shots	<input type="checkbox"/> FS Shots Report
<input type="radio"/> Choose Very Last Shot as the Correct Shot	
<input type="radio"/> Average multiple shots	
<input checked="" type="checkbox"/> Point Protection Status : ON	
BS and VA check routine	
<input checked="" type="checkbox"/> Back Sight (BS) Check	<input checked="" type="checkbox"/> Vertical Angle Check
Dist. Tolerance (m / feet)	<input type="text" value="0.05"/>
Angle Tolerance (dms)	<input type="text" value="0.01"/>
<input type="button" value="OK"/> <input type="button" value="Cancel"/> <input type="button" value="Help"/>	

After the traverse has been coordinated you will be returned to the Assistant.  
Pick the **EXIT** button to leave the Assistant.

Next go to the **MsTools** → **Print / Edit / View Reports** → **View Log** command:

You will see the following Window appear.

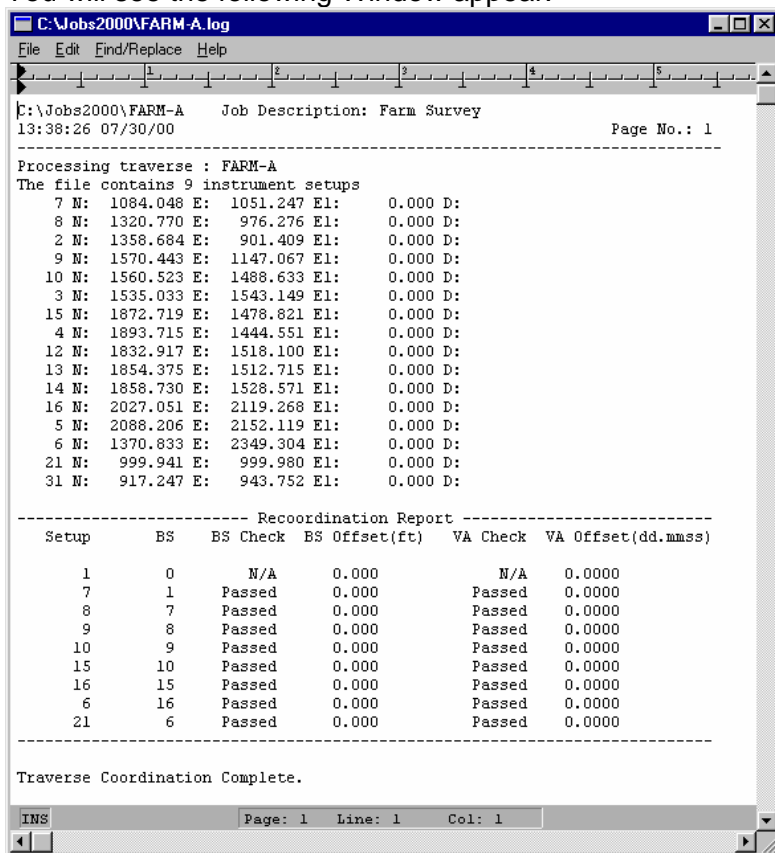

```
C:\Jobs2000\FARM-A.log
File Edit Find/Replace Help
-----
E:\Jobs2000\FARM-A Job Description: Farm Survey Page No.: 1
13:38:26 07/30/00
-----
Processing traverse : FARM-A
The file contains 9 instrument setups
7 N: 1084.048 E: 1051.247 El: 0.000 D:
8 N: 1320.770 E: 976.276 El: 0.000 D:
2 N: 1358.684 E: 901.409 El: 0.000 D:
9 N: 1570.443 E: 1147.067 El: 0.000 D:
10 N: 1560.523 E: 1488.633 El: 0.000 D:
3 N: 1535.033 E: 1543.149 El: 0.000 D:
15 N: 1872.719 E: 1478.821 El: 0.000 D:
4 N: 1893.715 E: 1444.551 El: 0.000 D:
12 N: 1832.917 E: 1518.100 El: 0.000 D:
13 N: 1854.375 E: 1512.715 El: 0.000 D:
14 N: 1858.730 E: 1528.571 El: 0.000 D:
16 N: 2027.051 E: 2119.268 El: 0.000 D:
5 N: 2088.206 E: 2152.119 El: 0.000 D:
6 N: 1370.833 E: 2349.304 El: 0.000 D:
21 N: 999.941 E: 999.980 El: 0.000 D:
31 N: 917.247 E: 943.752 El: 0.000 D:
-----
----- Reoordination Report -----
Setup BS BS Check BS Offset(ft) VA Check VA Offset(dd.mmss)
-----
1 0 N/A 0.000 N/A 0.0000
7 1 Passed 0.000 Passed 0.0000
8 7 Passed 0.000 Passed 0.0000
9 8 Passed 0.000 Passed 0.0000
10 9 Passed 0.000 Passed 0.0000
15 10 Passed 0.000 Passed 0.0000
16 15 Passed 0.000 Passed 0.0000
6 16 Passed 0.000 Passed 0.0000
21 6 Passed 0.000 Passed 0.0000
-----
Traverse Coordination Complete.
IMS Page: 1 Line: 1 Col: 1
```

You may print this report now by going to the **File** pulldown menu on this window, and pick the **Print** command.

Pick the **X** in the top right of the window to close it.

Pick the Zoom Extents Button on the right of the screen, 

Now your screen should look like this:

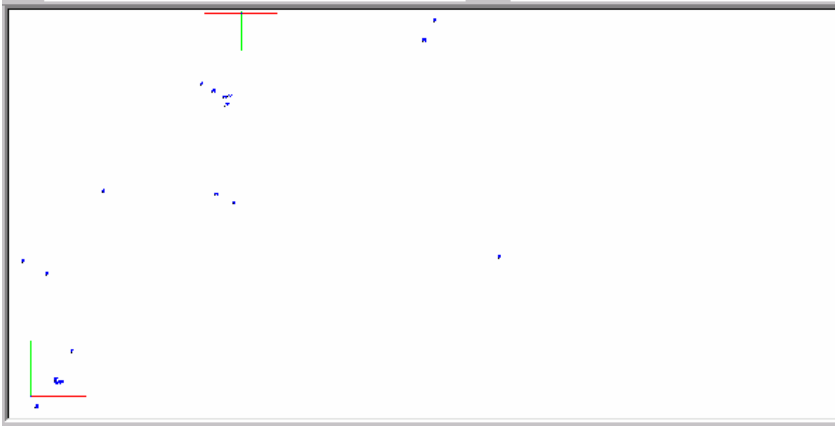

Save the project by entering the **SAVE** command.

### **Computing Closure**

Now we will compute the closure error. Select the **ASSISTANT** from the option bar, then pick the **Traverse Entry /Edit/ Adjustment** button. Then pick the **Compute Traverse Closure** button. You will be asked:

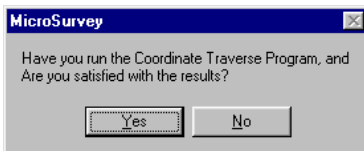

Pick the **YES** button to continue.

Now you will be asked if you have a **Closed Loop** or **Open** traverse.

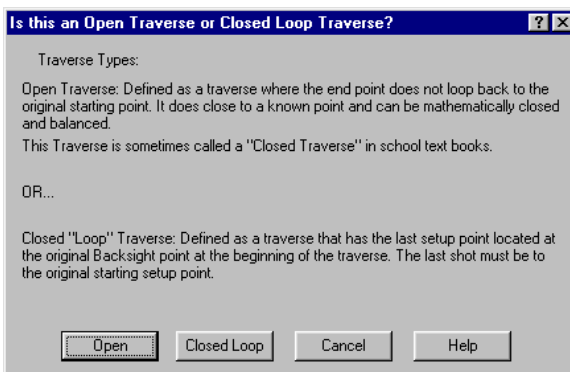

Select **Open Traverse**, because we have an external backsight and closing foresight on this traverse.

MicroSurvey quickly analyzes the traverse and finds the last instrument setup point number. It offers this as the closing point number: Our traverse matches the first of the 3 scenarios presented:

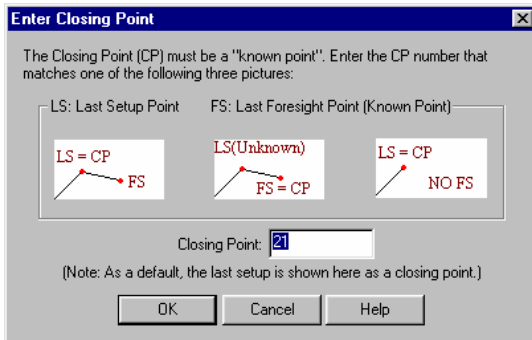

Pick the **OK** button to continue.

You will be shown the calculated coordinates of point 21:

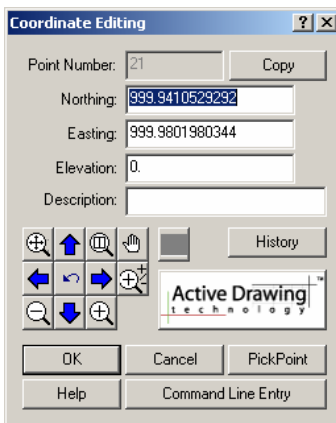

You must change these to reflect the true coordinates of point 21. To make this easy for you pick on the button marked **Copy**.

This brings up another dialog that allows you to enter in the point number that has the correct coordinates for point 21.



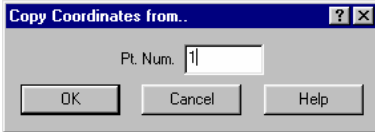

21 is the same point as 1 so enter point number 1 and Pick **OK** to return to the previous dialog.

It will now look like this:

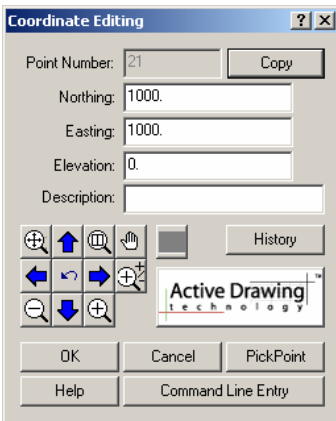

Pick the **OK** button to continue.

Enter Closing Foresight Point 31, as shown below:

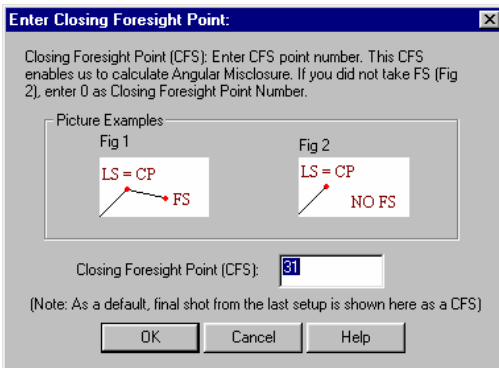

Pick the **OK** button to continue.

---

You are asked for the actual coordinates of point 31. The numbers shown are the calculated values. Enter in the following **KNOWN** values, as shown:

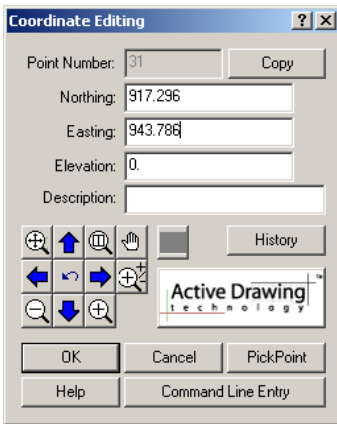

Pick the **OK** button to continue and the Traverse Closure Report will be generated on the Command Window.

Then pick the **EXIT** button on the Assistant.

Open the View Log (you can also open this with a button on the MsMainControl Toolbar) and then scroll down using the slide bar on the right, until you see the following. (Remember you can print this by going to the **File** pulldown menu on the Log Window and run the **Print** command.)

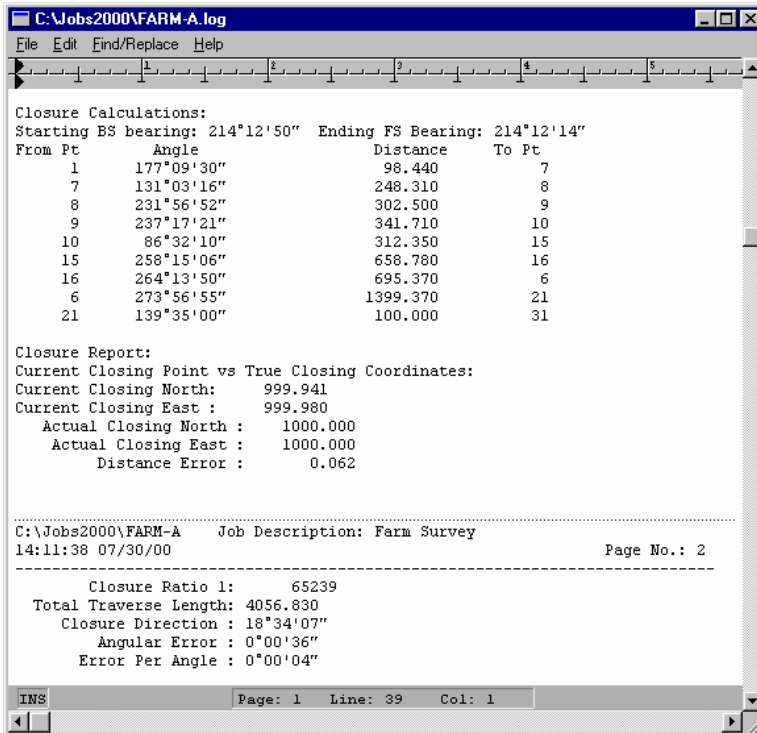

Pick the **X** in the top right corner of the window to close it.

### Adjust Angles + Compass Balance

We are now going to do an Angular Balance on this traverse. Go to the **MsTraverse drop-down menu -> Traverse Calculations** and pick on the **Angle Balance** option.

Answer **YES** to the following:

Point Protection is currently ON. The Angle Balance program requires that we turn this OFF. Can the program turn OFF Point Protection?

The angles on this traverse will be balanced. The closure will be recomputed and displayed. Pick on the **ViewLOG** button again and scroll down to the bottom to see the results shown here.

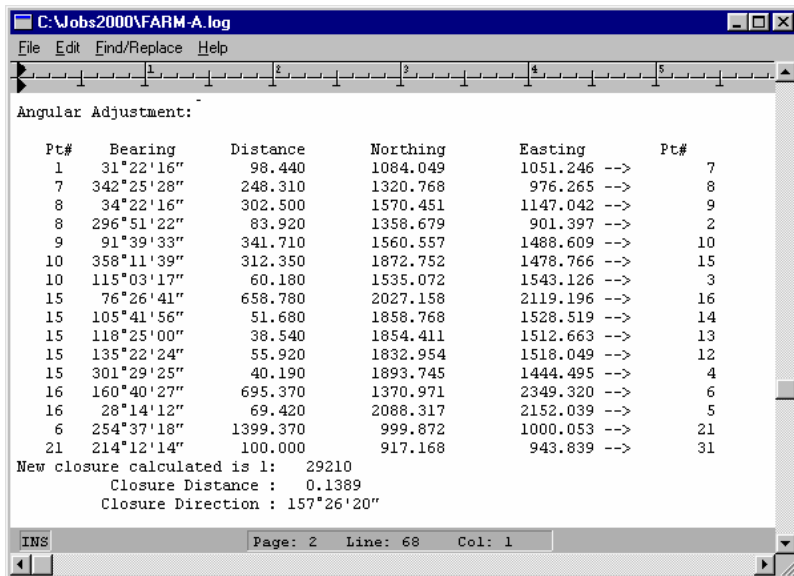

Pick the **X** in the top right corner of the window to close it.

Next you can perform a compass balance by going to the **MsTraverse drop-down menu -> Traverse Calculations** and pick on the **Compass Method Adjustment** option.

The traverse will be balanced according to the Compass Rule. The coordinates for the main traverse and any side shots will be adjusted.

Now Pick on the **ViewLOG** button again and scroll down to the bottom to see the results shown here.

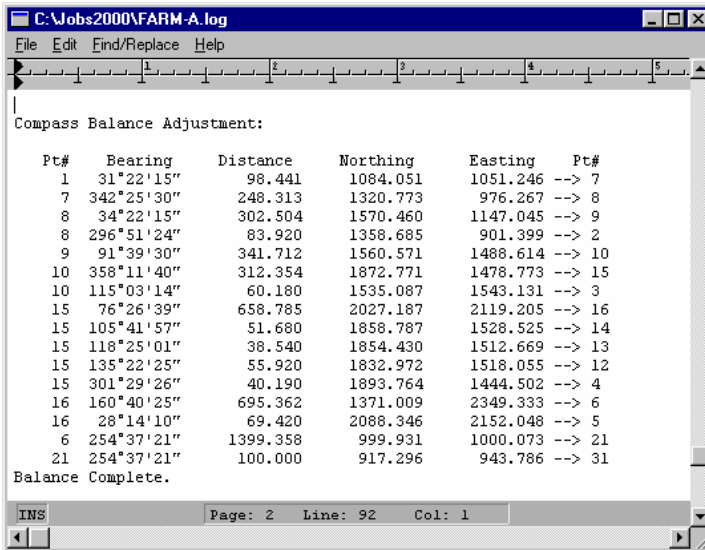

Pick the **X** in the top right corner of the window to close it.

Now lets see the traverse on the screen. to the **MsTraverse** drop-down menu - > **Traverse Entry/Editing** and pick on the **Show Traverse Graphically** option.

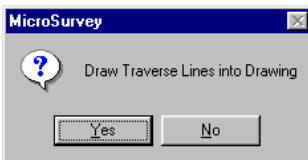

Answer **NO** if you wish to see the linework temporarily until a redraw command cleans up the screen. Answer **YES** if you wish to draw every line into the drawing permanently (with the toggles and labeling defaults controlling their appearance). Entering Yes will produce this drawing:

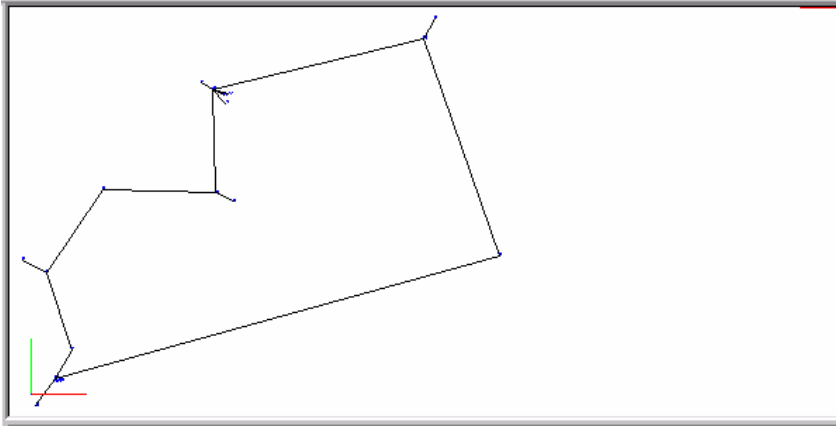

### Listing the Traverse

Finally, we will dump a listing of the traverse to the Log file. Go to the **MsTraverse drop-down menu -> Traverse Entry/Editing** and pick on the **List Traverse File** option.

There are two formats of the listing: long and short.

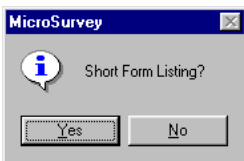

Pick **YES** for the Short Listing.

Now Pick on the **ViewLOG** button again and scroll down to the bottom to see the results shown here.



Keep scrolling to see the entire listing.

(Remember you can print this by going to the **File** pulldown menu and picking on the **Print** command.) Pick the **X** in the top right corner of the window to close it.

The new Active Drawing Technology Editor offers formatted listings of much higher quality than ever available before. To start the ADT editor, run the **Active Traverse Editor** command found in the **MsTraverse** menu. Following is a print preview from the File menu of the Editor:

Active Drawing Technology™ - [Traverse Editor : FARM-AA]

Print Next Page Prev Page Two Page Zoom In Zoom Out Close

Job Desc	Crew	Inst Num	Temp	Pressure	Start Date		
Traverse 1	West	101	70F		10/12/101		East
Station	BS Pt	BS Azm	BS Read	Inst Ht			
1		214°12'50"	0°00'00"	0.00			
Shot Pt	Trgt Ht	HZ Ang	Vt Ang	Slp Dist	Desc	North	East
7	0.00	177°09'30"	90°00'00"	98.44		1084.048	1051.247
Station	BS Pt	BS Azm	BS Read	Inst Ht			
7	1		0°00'00"	0.00			
Shot Pt	Trgt Ht	HZ Ang	Vt Ang	Slp Dist	Desc	North	East
8	0.00	131°03'16"	90°00'00"	248.31		1320.770	976.276
Station	BS Pt	BS Azm	BS Read	Inst Ht			
8	7		0°00'00"	0.00			
Shot Pt	Trgt Ht	HZ Ang	Vt Ang	Slp Dist	Desc	North	East
2	0.00	134°25'54"	90°00'00"	83.92		1358.684	901.409
9	0.00	231°56'52"	90°00'00"	302.50		1570.443	1147.067
Station	BS Pt	BS Azm	BS Read	Inst Ht			
9	8		0°00'00"	0.00			
Shot Pt	Trgt Ht	HZ Ang	Vt Ang	Slp Dist	Desc	North	East
10	0.00	237°17'21"	90°00'00"	341.71		1560.523	1488.633
Station	BS Pt	BS Azm	BS Read	Inst Ht			
10	9		0°00'00"	0.00			
Shot Pt	Trgt Ht	HZ Ang	Vt Ang	Slp Dist	Desc	North	East
3	0.00	203°23'44"	90°00'00"	60.18		1535.033	1543.149
15	0.00	86°32'10"	90°00'00"	312.35		1872.719	1478.821

(End of tutorial)



---

## Property Line Tutorial

Because of the size and complexity of this tutorial we have broken it down into 14 smaller steps to make it easier for you to follow.

Step 1) Starting the Job

Step 2) COGO Calcs (Property Boundaries)

Step 3) Distance/Distance Intersection

Step 4) 3 Point Curve

Step 5) More COGO

Step 6) Bearing/Distance Intersection

Step 7) And More COGO

Step 8) COGO One More Time

Step 9) More 3 Point Curves

Step 10) Setting the Toggles

Step 11) Locating the Buildings (Using OFFSETS)

Step 12) Work on the SHED

Step 13) Line Inverse

Step 14) Job Complete

## Starting the Job

In this tutorial, we will be using COGO Only, to calculate a drawing of three adjacent properties with a house and shed on the center property. During this tutorial, we will record our entry into the new **Active Batch Cogo System**. The figure below illustrates some of the field notes taken by a survey party to give you a feeling for what you are entering.

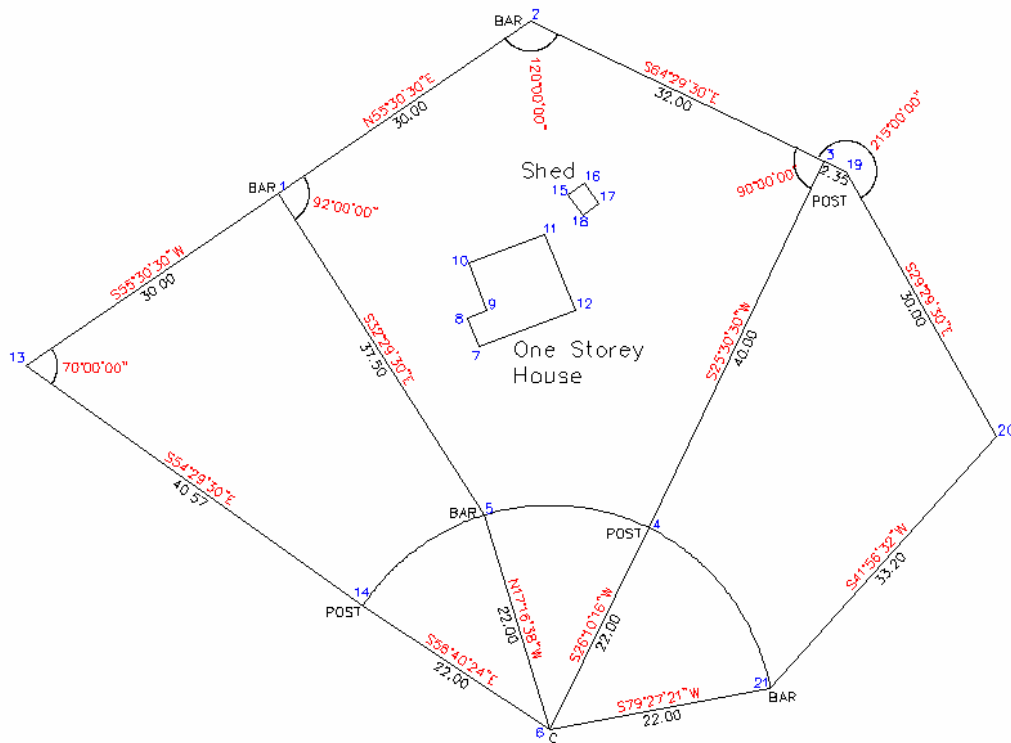

**Property field notes**

To begin, start a new drawing by running the New... command, found under the **File drop-down menu**.

Pick the New button in the Project Manager, and name the project **COGO**. Then pick **Save** to continue.

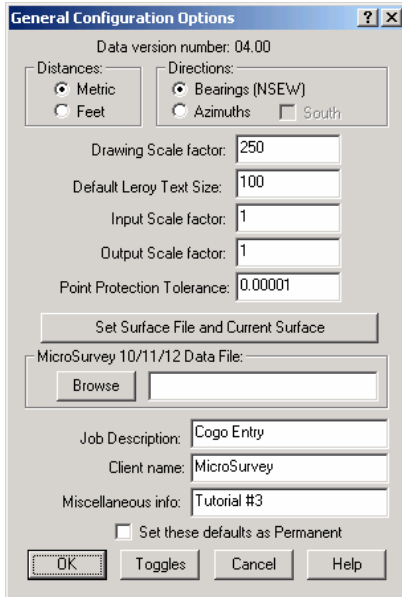

Set the MicroSurvey General Configuration Options to **Metric, Bearings** with a scale factor of **1:250**. This scale is chosen so the bearings and distances will be clear in MicroSurvey.

Using the same procedure as the Traverse tutorial, set up the MicroSurvey system toggles as shown.

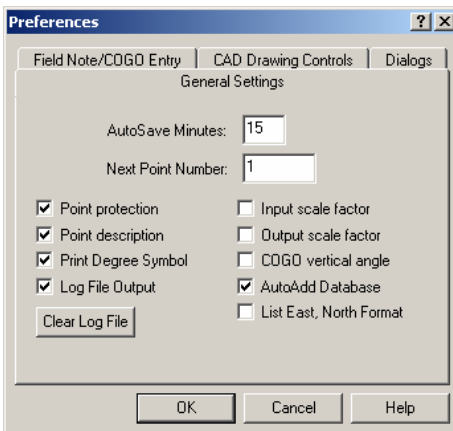

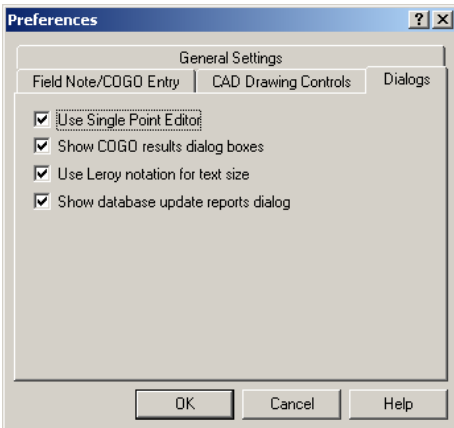
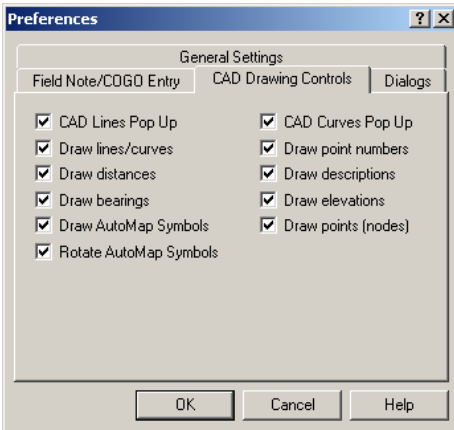
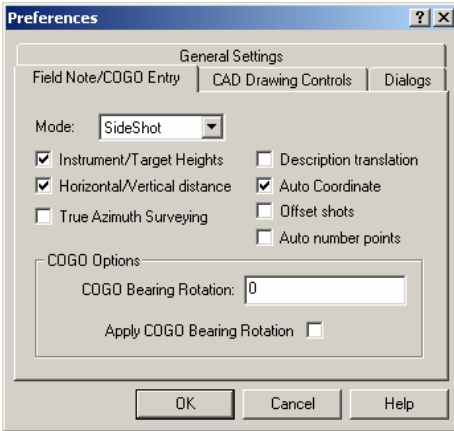

---

If the Assistant appears on screen, pick the EXIT button to remove it.

## **COGO Calcs (Property Boundaries)**

Before we start performing COGO calculations, turn on the Batch COGO recording control by typing: **MS\_BATCH** or select it from the **MsCogo → Active Batch COGO → Load Control Dialog**. The following dialog should appear



Pick the **Set** button and choose New:

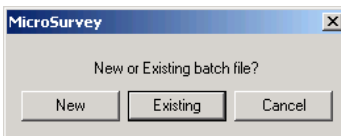

You will be prompted to enter a batch file name. Enter "**Property Line Tutorial**" and press **Save**.

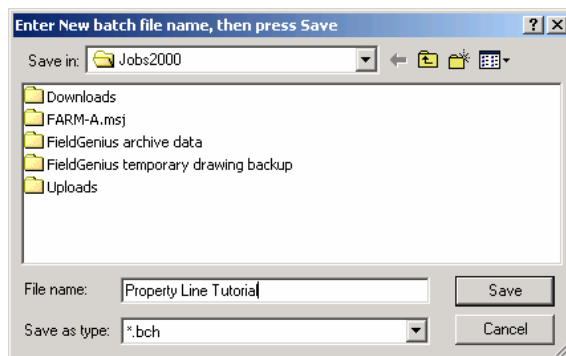

Note: We have included this batch file for your use as a later comparison, or if you want ***cheat***, you can just load the batch file and run it. Do not do this if you really want to learn how to use our COGO.

Now, **Pick the Start button**, and the dialog should show Recording ON.

To begin calculating the property boundaries, Type COGO at the MicroSurvey command prompt. Respond as shown to these prompts:

```
Inverse:Pt..Pt/Curve Inverse:Pt..Pt..Pt  
(Recording) Enter From Point <1>: 1 <Enter>
```

---

That coordinate is not in the file. Please enter it now.

Fill out the dialog as shown (be sure to use the mouse or the TAB key to move between fields in the dialog)

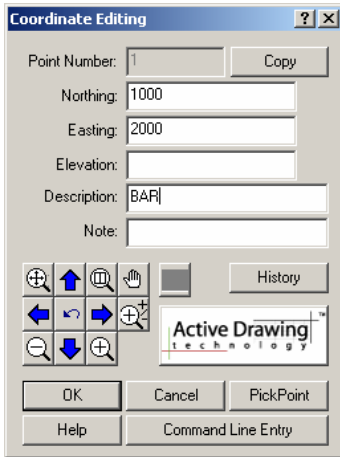

Pick the **OK** button to continue.

Because point #1 did not exist, MicroSurvey automatically asked you to define its location.

Inverse:Pt..Pt/Curve Inverse:Pt..Pt..Pt  
(Recording) Enter From Point: <1> **<Enter>**

Options: +/- or Pt..Pt+-Angle  
Enter Quadrant Bearing like QDD.MMSS:<>: **155.3030 <Enter>**

Options: C#=-\*/sin/cos/tan... or Pt..Pt(+-\*/\*) a Distance  
Enter the Distance: <>: **30 <Enter>**

Enter the Solve Point: <2>: **2 <Enter>**

Enter Description:<>: **BAR <Enter>**

1 N55°30'30"E 30.000 1016.989 2024.726 2

Pick the side you want the bearing placed/Above/Below: **A <Enter>**

---

The bearing you just entered can be read as: First Quadrant (1), Fifty-five degrees, Thirty minutes, Thirty seconds, or N 55° 30'30" E.

Inverse:Pt..Pt/Curve Inverse:Pt..Pt..Pt  
(Recording) Enter From Point: <2> **(At this point pick the Zoom Extents button on the left side menu so we can see the info already entered) ('ZOOMFIT will appear on the command line)**

(Recording) Enter From Point: <2> **<Enter>**  
Options: +/- or Pt..Pt+-Angle  
Enter Quadrant Bearing like QDD.MMSS:<>: **2..1-120 <Enter>**

Options: C#=-\*/sin/cos/tan... or Pt..Pt(+\*/\*) a Distance  
Enter the Distance: <>: **32 <Enter>**

Enter the Solve Point: <3>: **<Enter>**  
Enter Description:<BAR>: **POST <Enter>**

2 S64°29'30"E 32.000 1003.208 2053.607 3

Pick the side you want the bearing placed/Above/Below: **A <Enter>**

By replying to ENTER BEARING with "2..1-120", you told MicroSurvey to take the bearing from point 2 to point 1 and turn a counterclockwise angle of 120 degrees. Now let's continue...

Inverse:Pt..Pt/Curve Inverse:Pt..Pt..Pt  
(Recording) Enter From Point: <3> **<Enter>**

Options: +/- or Pt..Pt+-Angle  
Enter Quadrant Bearing like QDD.MMSS:<>: **2..3+90 <Enter>**

Options: C#=-\*/sin/cos/tan... or Pt..Pt(+\*/\*) a Distance  
Enter the Distance: <>: **40 <Enter>**

Enter the Solve Point: <4>: **<Enter>**

Enter Description:<POST>: **<Enter>**

3 S25°30'30"W 40.000 967.107 2036.381 4

---

Pick the side you want the bearing placed/Above/Below: **A <Enter>**

Inverse:Pt..Pt/Curve Inverse:Pt..Pt..Pt

(Recording) Enter From Point: <4> **ZE <Enter>** (**ZE is Zoom Extents**)

At this point the screen should look like this:

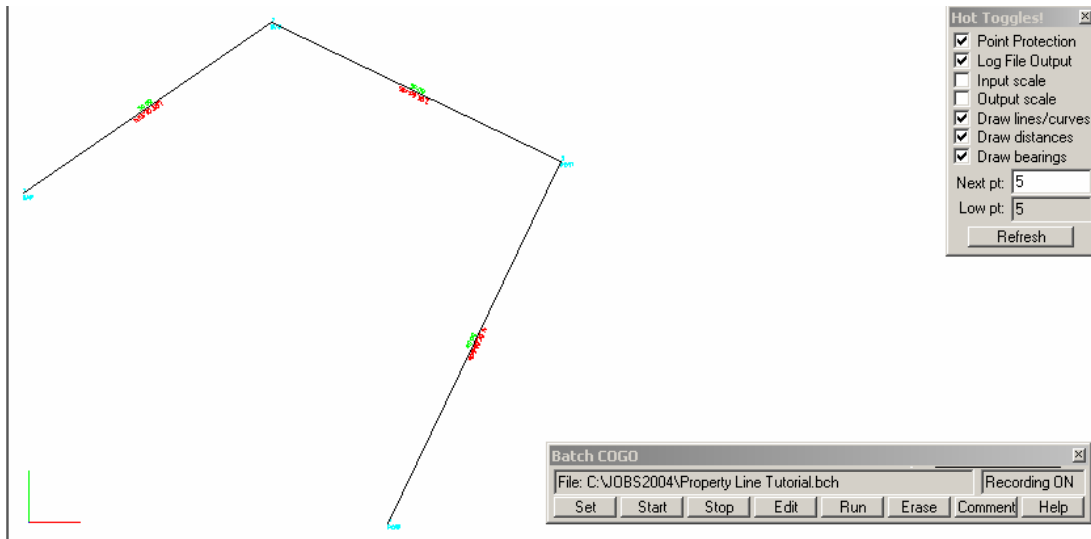

Rather than continuing from point 4, we are going to jump back to point 1 and started a new calculation:

(Recording) Enter From Point: <4>**1 <Enter>**

Options: +/- or Pt..Pt+-Angle

Enter Quadrant Bearing like QDD.MMSS:<>: **1..2+92 <Enter>**

Options: C#=-\*/sin/cos/tan... or Pt..Pt(+-\*/) a Distance

Enter the Distance: <>: **37.5 <Enter>**

Enter the Solve Point: <5>: **<Enter>**

Enter Description:<BAR>: **<Enter>**



---

1 S32°29'30"E 37.500 968.370 2020.144 5

Pick the side you want the bearing placed/Above/Below: **A** <Enter>

### Distance/Distance Intersection

Next is a DISTANCE - DISTANCE calculation so we can establish the center point of the curve at the front of the property.

Inverse:Pt..Pt/Curve Inverse:Pt..Pt..Pt  
(Recording) Enter From Point: <5> **4** <Enter>

Options: +/- or Pt..Pt+-Angle  
Enter Quadrant Bearing like QDD.MMSS:<>: <Enter>

Options: C#=-\*/sin/cos/tan... or Pt..Pt(+-\*/) a Distance  
Enter the Distance: <>: **22** <Enter>

Enter the Solve Point: <6>: <Enter>

Options: C#=-\*/sin/cos/tan... or Pt..Pt(+-\*/) a Distance  
Enter Distance2: <>: **22** <Enter>

Enter the To Point: <5> <Enter>

Point :6 North : 947.363 East : 2026.678

Do you want to use this solution (Y/N) (N for other solution) **Y** <Enter>

4 S26°10'16"W 22.000 947.363 2026.678 6

Enter Description:<BAR>: **C** <Enter>

Pick the side you want the bearing placed/Above/Below: **A** <Enter>

6 N17°16'38"W 22.000 968.370 2020.144 5

Pick the side you want the bearing placed/Above/Below: **A** <Enter>

---

Point :6 North : 947.363 East : 2026.678

Inverse:Pt..Pt/Curve Inverse:Pt..Pt..Pt  
(Recording) Enter From Point: <6> **ZE** <Enter> (**ZE is Zoom Extents**)

Note that no special commands were required to do the DISTANCE - DISTANCE calculation; MicroSurvey knew to do this when you replied to a bearing prompt with the <enter> key. This logic is followed for all intersection calculations. Since this calculation yields two possible solutions, you were offered the opportunity to use the "other" solution. Generally MicroSurvey works in a clockwise manner, so the first solution offered is usually the clockwise solution.

### 3 Point Curve

Now we do a 3 point inverse to draw the curve and get the curve information:

Inverse:Pt..Pt/Curve Inverse:Pt..Pt..Pt  
(Recording) Enter From Point: <6>**5..6..4** <Enter>

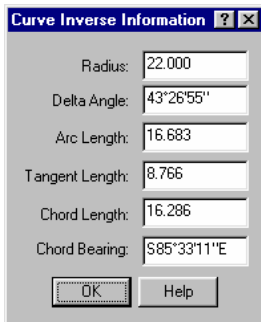

Arc: 16.68 Chord: 16.29 Tangent: 8.77  
Delta: 43.2655 Radius: 22.00

By entering three numbers as shown above, you told MicroSurvey to compute an angle clockwise from point 5 to point 4 with point 6 as the center of curvature.

You should see this now:

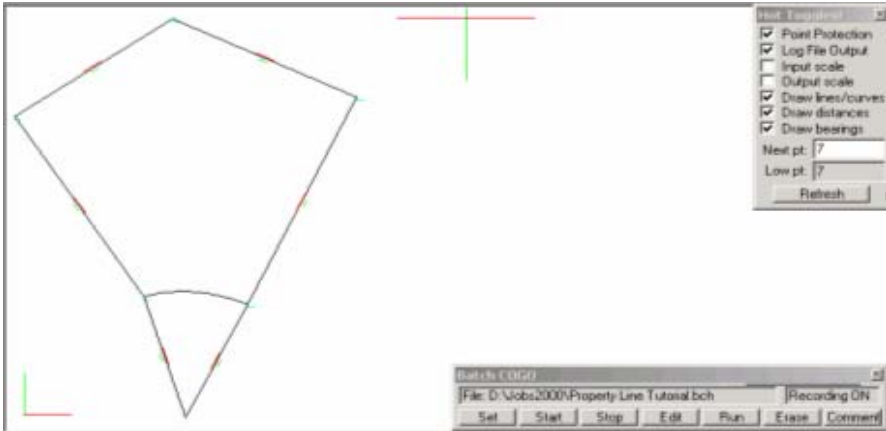

## More COGO

Inverse:Pt..Pt/Curve Inverse:Pt..Pt..Pt  
 (Recording) Enter From Point: <6> **1** <Enter>

Options: +/- or Pt..Pt+-Angle  
 Enter Quadrant Bearing like QDD.MMSS:<>: **2.1** <Enter>

Options: C#=-\*/sin/cos/tan... or Pt..Pt(+-\*/) a Distance  
 Enter the Distance: <>: **2.1** <Enter>

Enter the Solve Point: <7>: **13** <Enter>  
 Enter Description:<C>: **(space)** <Enter>

1 S55°30'30"W 30.000 983.011 1975.274 13

Pick the side you want the bearing placed/Above/Below: **A** <Enter>

Entering the distance as "2.1" tells MicroSurvey to use the distance from point 2 to point 1, or 30 meters in this case.

---

## Bearing/Distance Intersection

Next we want to do a BEARING - DISTANCE calculation from point 13 and point 6. Again, we will get two possible solutions and this time the "other" solution will be the one we want.

Inverse:Pt..Pt/Curve Inverse:Pt..Pt..Pt  
(Recording) Enter From Point: <13> ZE <Enter> (ZE is Zoom Extents)

At this point your drawing should look like this:

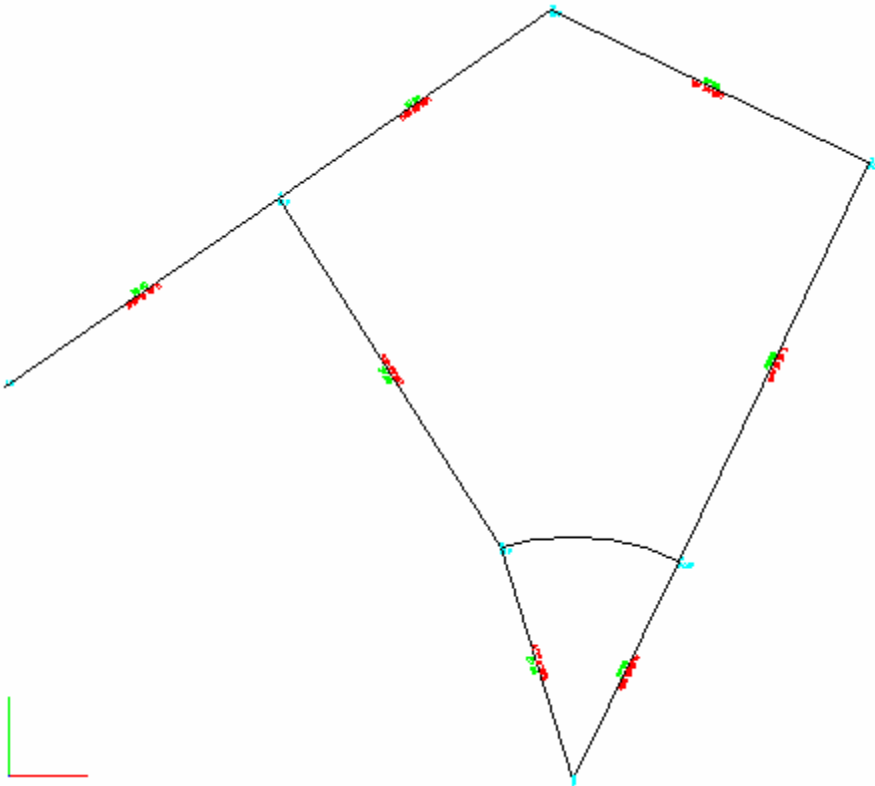

(Recording) Enter From Point: <13> <Enter>

Options: +/- or Pt..Pt+-Angle

Enter Quadrant Bearing like QDD.MMSS:<>: 13..1+70 <Enter>

---

Options: C#=-\*/sin/cos/tan... or Pt..Pt(+-\*/) a Distance  
Enter the Distance: <>: **<Enter>**

Enter the Solve Point: <14>: **<Enter>**

Options: +/- or Pt..Pt+-Angle  
Enter Quadrant Bearing #2 like QDD.MMSS: <>: **<Enter>**

Options: C#=-\*/sin/cos/tan... or Pt..Pt(+-\*/) a Distance  
Enter Distance2: <>: **22 <Enter>**

Enter the To Point: <14> **6 <Enter>**

Point :14 North : 933.912 East : 2044.087  
Do you want to use this solution (Y/N) (N for other solution) **N <Enter>**

Point :14 North : 959.450 East : 2008.296  
Do you want to use this solution (Y/N) (N for other solution) **Y <Enter>**

13 N56°40'24"W 22.000 959.450 2008.296 14

Enter Description:< >: **POST <Enter>**

Pick the side you want the bearing placed/Above/Below: **A <Enter>**

14 S56°40'24"E 22.000 947.363 2026.678 6

Pick the side you want the bearing placed/Above/Below: **A <Enter>**



Do a redraw to ensure the screen looks clean by picking the button at the top left of the screen.

### And More COGO

Now we calculate point 19:

Inverse:Pt..Pt/Curve Inverse:Pt..Pt..Pt  
(Recording) Enter From Point: <14> **3 <Enter>**

---

Options: +/- or Pt..Pt+-Angle

Enter Quadrant Bearing like QDD.MMSS:<>: **2..3** <Enter>

Options: C#=-\*/sin/cos/tan... or Pt..Pt(+-\*/) a Distance

Enter the Distance: <>: **2.35** <Enter>

Enter the Solve Point: <7>: **19** <Enter>

Enter Description:<POST>: **(space)** <Enter>

3 S64°29'30"E 2.350 1002.196 2055.728 19

Pick the side you want the bearing placed/Above/Below: **A** <Enter>

Since we did not want any description for this point, we used the spacebar to blank the default that was offered. Now we calculate Point 20:

Inverse:Pt..Pt/Curve Inverse:Pt..Pt..Pt

(Recording) Enter From Point: <19> <Enter>

Options: +/- or Pt..Pt+-Angle

Enter Quadrant Bearing like QDD.MMSS:<>: **229.2930** <Enter>

Options: C#=-\*/sin/cos/tan... or Pt..Pt(+-\*/) a Distance

Enter the Distance: <>: **1..2** <Enter>

Enter the Solve Point: <7>: **20** <Enter>

Enter Description:<BAR>: **(space)** <Enter>

19 S29°29'30"E 30.000 976.083 2070.497 20

Pick the side you want the bearing placed/Above/Below: **A** <Enter>

Now we will calculate Point 21 using a Distance-Distance Intersection. Take the second distance from the points on the drawing by entering a two point inverse:

Inverse:Pt..Pt/Curve Inverse:Pt..Pt..Pt

(Recording) Enter From Point:<20> <Enter>

Options: +/- or Pt..Pt+-Angle

---

Enter Quadrant Bearing like QDD.MMSS:<>: **<Enter>**

Options: C#=-\*/sin/cos/tan... or Pt..Pt(++\*/) a Distance

Enter the Distance: <>: **33.2 <Enter>**

Enter the Solve Point: <21>: **<Enter>**

Options: C#=-\*/sin/cos/tan... or Pt..Pt(++\*/) a Distance

Enter Distance2: <>: **4.6 <Enter>**

Enter the To Point: <21> **6 <Enter>**

Point :21 North : 951.388 East : 2048.307

Do you want to use this solution (Y/N) (N for other solution) **Y <Enter>**

20 S41°56'32"W 33.200 951.388 2048.307 21

Enter Description:< >: **BAR <Enter>**

Pick the side you want the bearing placed/Above/Below: **A <Enter>**

21 S79°27'21"W 22.000 947.363 2026.678 6

Pick the side you want the bearing placed/Above/Below: **A <Enter>**

Point :21 North : 951.388 East : 2048.307

### **More 3 Point Curves**

Next we do a 3 point inverse to draw the curve between points 4 and 21 and get the curve information:

Inverse:Pt..Pt/Curve Inverse:Pt..Pt..Pt

(Recording) Enter From Point: <21> **4..6..21 <Enter>**

Curve Inverse Information ? X

Radius: 22.000

Delta Angle: 53°17'05"

Arc Length: 20.460

Tangent Length: 11.037

Chord Length: 19.730

Chord Bearing: S37°11'11"E

OK Help

Arc: 20.46 Chord: 19.73 Tangent: 11.04  
 Delta: 53.1705 Radius: 22.00

And the last curve can be calculated between points 14 and 5.

Inverse:Pt..Pt/Curve Inverse:Pt..Pt..Pt  
 (Recording) Enter From Point: <21> **14..6..5 <Enter>**

Curve Inverse Information ? X

Radius: 22.000

Delta Angle: 39°23'45"

Arc Length: 15.127

Tangent Length: 7.876

Chord Length: 14.831

Chord Bearing: N53°01'29"E

OK Help

Arc: 15.13 Chord: 14.83 Tangent: 7.88  
 Delta: 39.2345 Radius: 22.00

### Setting the Toggles

At this point your job should look like this:



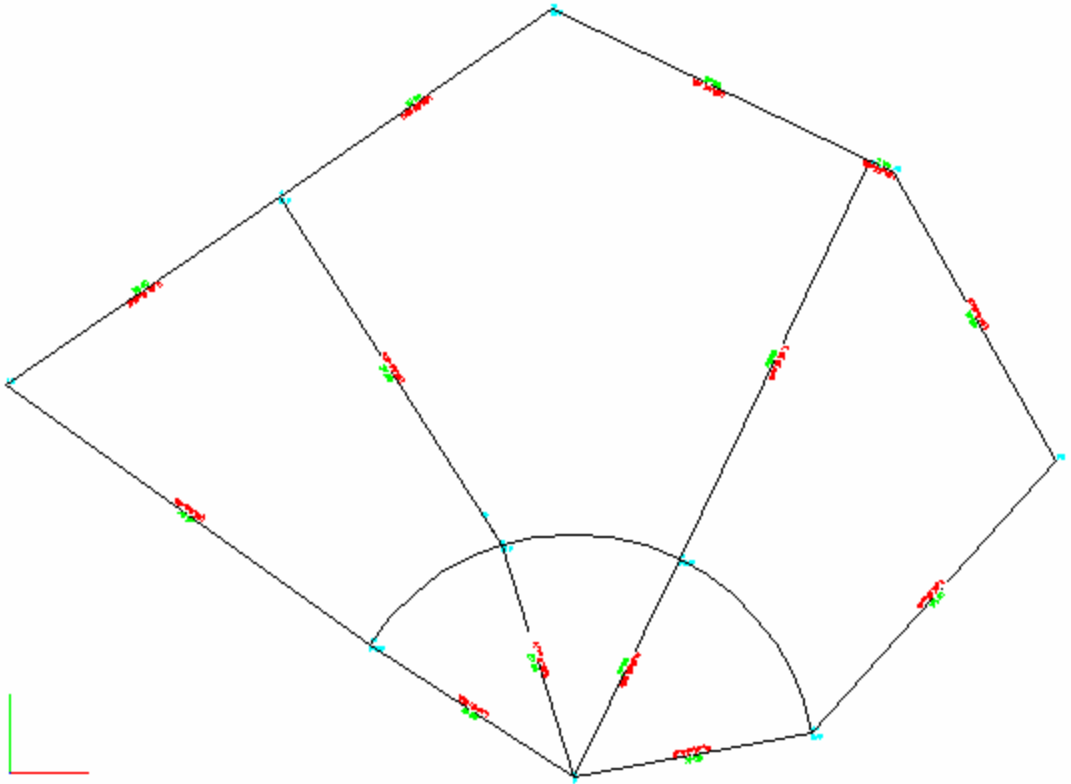

Now we will use the Hot Toggles dialog to change the toggles so that MicroSurvey will not draw bearings and distances on the sides of the house and shed.

Click on the **Draw Bearings** toggle.  
Click on the **Draw Distances** toggle.

The Hot Toggles dialog should now look like this:

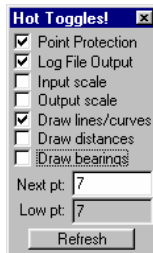

---

## Locating the Buildings (Using OFFSETS)

Now we will locate the house and shed on the center property. The figure below shows these structures in expanded detail as defined by the field notes.

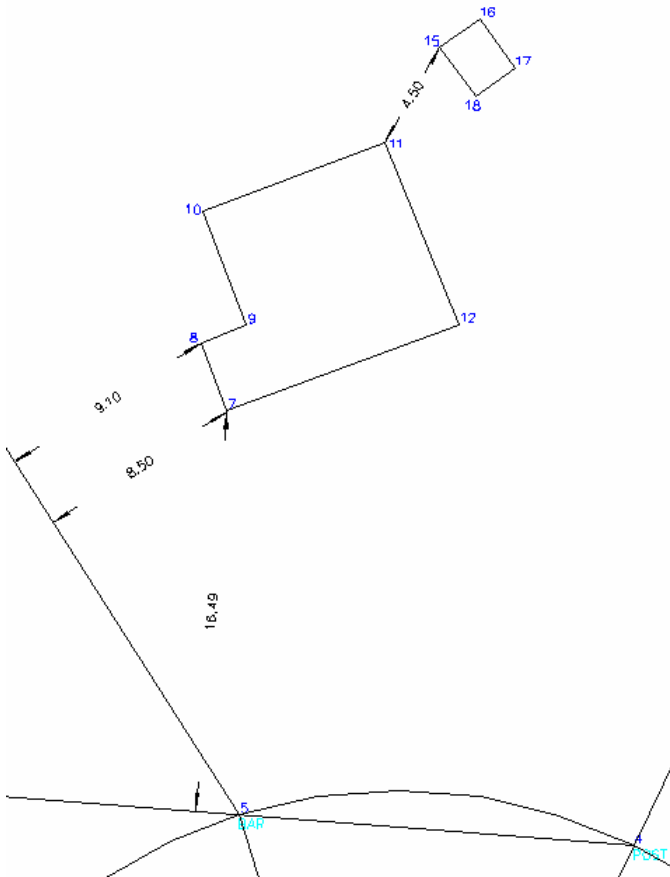

We begin locating the structures with a BEARING - BEARING intersection with OFFSETS. The bearings are taken from the lines by doing two point inverses. The offset distances are entered by using a % sign. Long ago one of our customers said they always write their field notes with o/s to signify offsets so they recommend we use the % sign. It works...

```
Inverse:Pt..Pt/Curve Inverse:Pt..Pt..Pt  
(Recording) Enter From Point: <21> 5 <Enter>
```

---

Options: +/- or Pt..Pt+-Angle  
Enter Quadrant Bearing like QDD.MMSS:<>: **5..1%8.5 <Enter>**

Options: C#=-\*/sin/cos/tan... or Pt..Pt(+-\*/) a Distance  
Enter the Distance: <>: **<Enter>**

Enter the Solve Point: <7>: **<Enter>**

Options: +/- or Pt..Pt+-Angle  
Enter Quadrant Bearing #2 like QDD.MMSS:<>:**5..4%-16.49 <enter>**

Enter the To Point: <6> **5 <Enter>**

Enter Description:<C> **(space) <Enter>**

5	N01°39'31"W	16.584	984.947	2019.664	7
7	S01°39'31"E	16.584	968.370	2020.144	5

To review: the % sign used in the bearings tells MicroSurvey that you are entering information on an offset. Positive is to the right and negative is to the left of the reference line.

Next is a BEARING - DISTANCE intersection with an OFFSET.

Inverse:Pt..Pt/Curve Inverse:Pt..Pt..Pt  
(Recording) Enter From Point: <7> **5 <Enter>**

Options: +/- or Pt..Pt+-Angle  
Enter Quadrant Bearing like QDD.MMSS:<>: **5..1%9.1 <Enter>**

Options: C#=-\*/sin/cos/tan... or Pt..Pt(+-\*/) a Distance  
Enter the Distance: <>: **<Enter>**

Enter the Solve Point: <8>: **<Enter>**

Options: +/- or Pt..Pt+-Angle  
Enter Quadrant Bearing #2 like QDD. SS: <>: **<Enter>**

Options: C#=-\*/sin/cos/tan... or Pt..Pt(+-\*/) a Distance  
Enter Distance2: <>: **3 <Enter>**

---

Enter the To Point: <6> **7** <Enter>

Point :8 North : 987.749 East : 2018.591

Do you want to use this solution (Y/N) (N for other solution) **Y** <Enter>

5 N20°57'17"W 3.000 987.749 2018.591 8

Enter Description:<C>: **(space)** <Enter>

8 S20°57'17"E 3.000 984.947 2019.664 7

Inverse:Pt..Pt/Curve Inverse:Pt..Pt..Pt  
(Recording) Enter From Point: <8> <Enter>

Options: +/- or Pt..Pt+-Angle

Enter Quadrant Bearing like QDD.MMSS:<>: **8..7-90** <Enter>

Options: C#=-\*/sin/cos/tan... or Pt..Pt(+-\*//) a Distance

Enter the Distance: <>: **2** <Enter>

Enter the Solve Point: <9>: <Enter>

Enter Description:< >: <Enter>

8 N69°02'43"E 2.000 988.464 2020.459 9

Inverse:Pt..Pt/Curve Inverse:Pt..Pt..Pt  
(Recording) Enter From Point: <9> <Enter>

Options: +/- or Pt..Pt+-Angle

Enter Quadrant Bearing like QDD.MMSS:<>: **9..8+90** <Enter>

Options: C#=-\*/sin/cos/tan... or Pt..Pt(+-\*//) a Distance

Enter the Distance: <>: **5** <Enter>

Enter the Solve Point: <10>: <Enter>

Enter Description:< >: <Enter>

9 N20°57'17"W 5.000 993.133 2018.671 10

---

Inverse:Pt..Pt/Curve Inverse:Pt..Pt..Pt  
(Recording) Enter From Point: <10> **<Enter>**

Options: +/- or Pt..Pt+-Angle  
Enter Quadrant Bearing like QDD.MMSS:<>: **10.9-90 <Enter>**

Options: C#=-\*/sin/cos/tan... or Pt..Pt(+-\*/) a Distance  
Enter the Distance: <>: **8 <Enter>**

Enter the Solve Point: <11>: **<Enter>**

Enter Description:< >: **<Enter>**

10 N69°02'43"E 8.000 995.994 2026.142 11

Inverse:Pt..Pt/Curve Inverse:Pt..Pt..Pt  
(Recording) Enter From Point: <11> **<Enter>**

Options: +/- or Pt..Pt+-Angle  
Enter Quadrant Bearing like QDD.MMSS:<>: **<Enter>**

Options: C#=-\*/sin/cos/tan... or Pt..Pt(+-\*/) a Distance  
Enter the Distance: <>: **8.1 <Enter>**

Enter the Solve Point: <12>: **<Enter>**

Options: C#=-\*/sin/cos/tan... or Pt..Pt(+-\*/) a Distance  
Enter Distance2: <>: **10.2 <Enter>**

Enter the To Point: <12> **7 <Enter>**

Point :12 North : 988.504 East : 2029.224

Do you want to use this solution (Y/N) (N for other solution) **Y <Enter>**

11 S22°21'59"E 8.100 988.504 2029.224 12

Enter Description:< >: **<Enter>**

12 S69°35'36"W 10.200 984.947 2019.664 7

---

Point :12 North : 988.504 East : 2029.224

### **Work on the SHED**

This completes the house; now we proceed to the shed. For the following DISTANCE - DISTANCE calculation, we will select the "other", or NEAR solution.

Inverse:Pt..Pt/Curve Inverse:Pt..Pt..Pt  
(Recording) Enter From Point: <12> **11** <Enter>

Options: +/- or Pt..Pt+-Angle  
Enter Quadrant Bearing like QDD.MMSS:<>: <Enter>

Options: C#=-\*/sin/cos/tan... or Pt..Pt(+-\*/) a Distance  
Enter the Distance: <>: **4.5** <Enter>

Enter the Solve Point: <15>: <Enter>

Options: C#=-\*/sin/cos/tan... or Pt..Pt(+-\*/) a Distance  
Enter Distance2: <>: **17.5** <Enter>

Enter the To Point: <12> **2** <Enter>

Point :15 North : 999.541 East : 2023.372

Do you want to use this solution (Y/N) (N for other solution) **N** <Enter>

Point :15 North : 999.881 East : 2028.410

Do you want to use this solution (Y/N) (N for other solution) **Y** <Enter>

11 N30°16'10"E 4.500 999.881 2028.410 15

Enter Description:< >: <Enter>

15 N12°09'07"W 17.500 1016.989 2024.726 2

Point :15 North : 999.881 East : 2028.410

Inverse:Pt..Pt/Curve Inverse:Pt..Pt..Pt  
(Recording) Enter From Point: <15> **2** <Enter>

---

Options: +/- or Pt..Pt+-Angle

Enter Quadrant Bearing like QDD.MMSS:<>: **<Enter>**

Options: C#=-\*/sin/cos/tan... or Pt..Pt(+-\*/) a Distance

Enter the Distance: <>: **16.8 <Enter>**

Enter the Solve Point: <16>: **<Enter>**

Options: C#=-\*/sin/cos/tan... or Pt..Pt(+-\*/) a Distance

Enter Distance2: <>: **2 <Enter>**

Enter the To Point: <3> **15 <Enter>**

Point :16 North : 1001.049 East : 2030.033

Do you want to use this solution (Y/N) (N for other solution) **Y <Enter>**

2 S18°24'55"E 16.800 1001.049 2030.033 16

Enter Description:<POST>: **(space) <Enter>**

16 S54°15'40"W 2.000 999.881 2028.410 15

Point :16 North : 1001.049 East : 2030.033

Inverse:Pt..Pt/Curve Inverse:Pt..Pt..Pt

(Recording) Enter From Point: <16> **<Enter>**

Options: +/- or Pt..Pt+-Angle

Enter Quadrant Bearing like QDD.MMSS:<>: **16..15-90 <Enter>**

Options: C#=-\*/sin/cos/tan... or Pt..Pt(+-\*/) a Distance

Enter the Distance: <>: **2.5 <Enter>**

Enter the Solve Point: <17> : **<Enter>**

Enter Description:< >: **<Enter>**

16 S35°44'20"E 2.500 999.020 2031.494 17

---

Inverse:Pt..Pt/Curve Inverse:Pt..Pt..Pt  
(Recording) Enter From Point: <17> **<Enter>**

Options: +/- or Pt..Pt+-Angle  
Enter Quadrant Bearing like QDD.MMSS:<>: **17..16-90 <Enter>**

Options: C#=-\*/sin/cos/tan... or Pt..Pt(+-\*/) a Distance  
Enter the Distance: <>: **15..16 <Enter>**

Enter the Solve Point: <18> : **<Enter>**

Enter Description:< >: **<Enter>**

17 S54°15'40"W 2.000 997.851 2029.870 18

We need to erase a few extra lines that are on the drawing, but at this point your drawing should look like this:



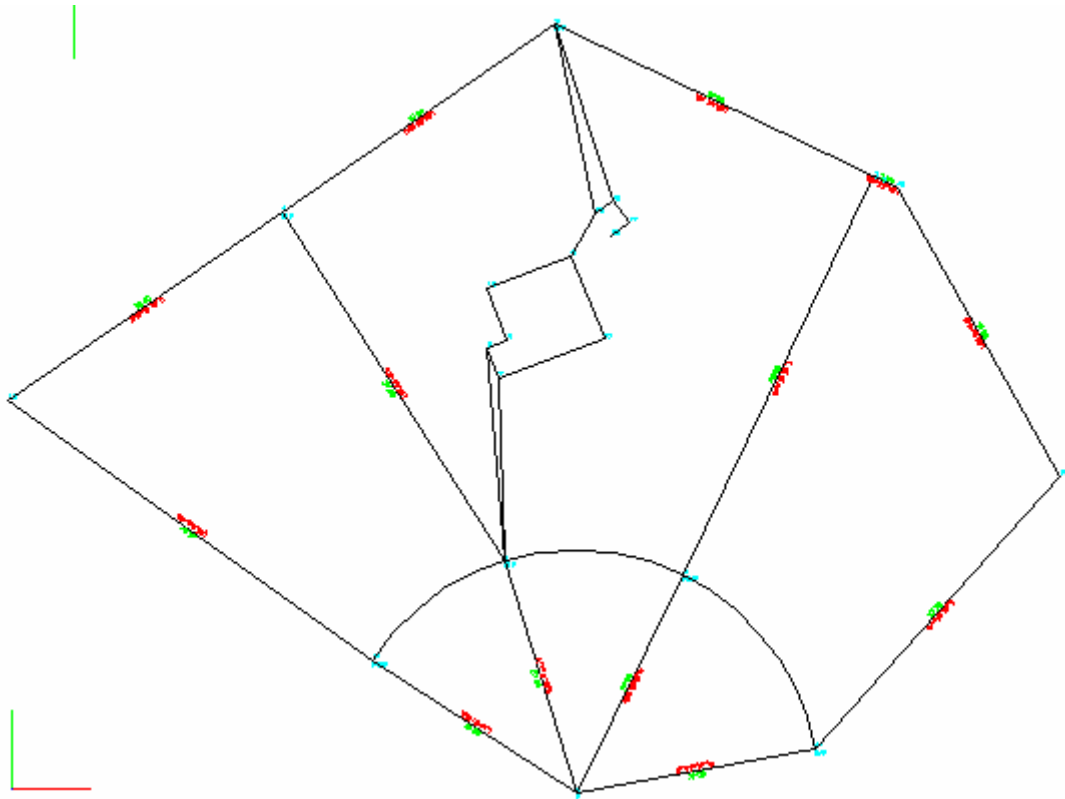

---

## Line Inverse

Inverse:Pt..Pt/Curve Inverse:Pt..Pt..Pt  
(Recording) Enter From Point: <18> **15..18** <Enter>

	Number:	Northing:	Easting:	Elevation:
Starting Point:	15	999.881	2028.410	0.000
Ending Point:	18	997.851	2029.870	0.000
Bearing/Azimuth:	S35°44'20"E		Distance:	2.500
			Scaled Distance:	

OK Help

You should see this information dialog. Press the Ok button:

15 S35°44'20"E 2.500 997.851 2029.870 18

Inverse:Pt..Pt/Curve Inverse:Pt..Pt..Pt  
(Recording) Enter From Point: <18> **Esc**

## Job Complete

The shed is now complete. Finally, by deleting unneeded lines, we get the property drawing shown below.

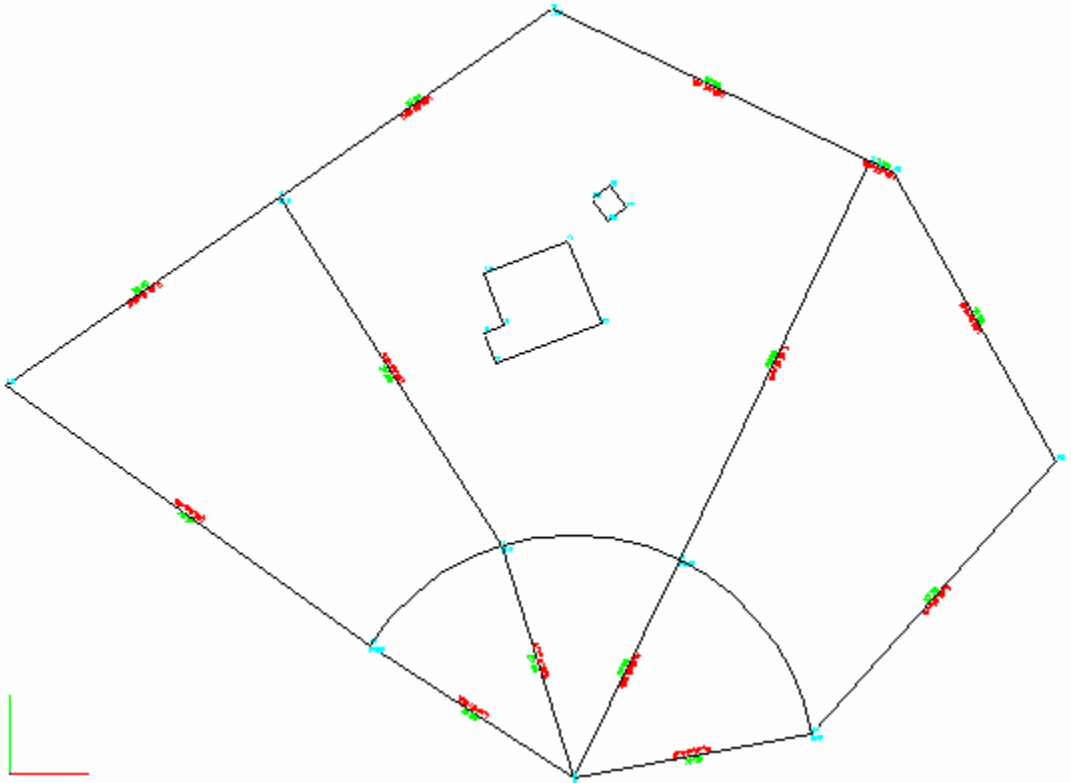

### **Final property drawing**

Save your job by picking the **SAVE** command from the **File pulldown menu**.

Now, Pick the Stop button on the Batch COGO Control window. It should show Recording OFF.

Pick the Edit button and you should see something like this window. It has been expanded so you can see more:

Active Drawing Technology™ - [Batch COGO Editor : Property Line Tutorial]

File Edit Window Help

BU	QU									
TL	ON									
TB	ON									
TD	ON									
TF	ON									
SP	1	1000.000000	2000.000000	0.00000000	BAR					
TR	1	155.3030	30	2	BAR					
TR	2	2.1-120	32	3	POST					
TR	3	2.3+90	40	4	POST					
TR	1	1.2+92	37.5	5	BAR					
DD	4	22	6	22	5	cw	C			
TR	1	2.1	2.1	13						
BD	13	13.1+70	14	22	6	ccw	POST			
TR	3	2.3	2.35	19						
TR	19	229.2930	1.2	20						
DD	20	33.2	21	4.6	6	cw	BAR			
TD	OFF									
TB	OFF									
BB	5	5.1%8.5	7	5.4%-16.49	5					
BD	5	5.1%9.1	8	3	7	cw				
TR	8	8.7-90	2	9						
TR	9	9.8+90	5	10						
TR	10	10.9-90	8	11						
DD	11	8.10	12	10.2	7	cw				
DD	11	4.5	15	17.5	2	ccw				
DD	2	16.8	16	2	15	cw				
TR	16	16.15-90	2.5	17						
TR	17	17.16-90	15.16	18						

Pick the SP and you can edit the starting coordinates.

	Store Pt	Pt Num	North	East	Elev	Description
▶	SP	1	1000.000000	2000.000000	0.00000000	BAR

Pick the Edit menu and you can see all the commands available for building a batch file:

Undo	Ctrl+Z
Redo	Ctrl+Y
Copy	Ctrl+C
Duplicate	Ctrl+D
Paste	Ctrl+V
Delete	
Find...	Ctrl+F
Run Batch File	Ctrl+R
Interactive Mode	
Convert To Comments	
Convert from Comments	
Insert Bearing-Bearing (BB)	
Insert Bearing-Distance (BD)	
Insert Bearing Units (BU)	
Insert Closure Finish (CF)	
Insert Closure Start (CS)	
Insert Comment	
Insert Curve (CU)	
Insert Distance-Angle (DA)	
Insert Distance-Distance (DD)	
Insert Delete Point (DP)	
Insert Inverse (IN)	
Insert List Point (LP)	
Insert Store Point (SP)	
Insert Toggle Bearings (TB)	
Insert Toggle Distances (TD)	
Insert Toggle File (TF)	
Insert Toggle Lines (TL)	
Insert Traverse (TR)	

Scroll to the Bottom of the Grid and Pick the Type Cell → it will change to a pull down combo box with all the record types listed:

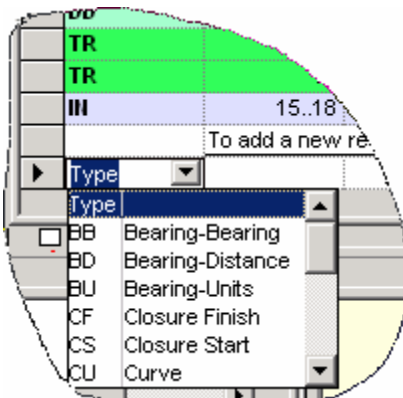

(End of tutorial)

---

## **Earthwork Volume Tutorial**

Because of the size and complexity of this tutorial we have broken it down into 14 smaller steps to make it easier for you to follow.

Step 1) Starting the Job

Step 2) Setting the Defaults and Toggles

Step 3) Importing a Data Collector File

Step 4) Creating the Traverse File

Step 5) Processing and Editing the Traverse File

Step 6) Coordinate the Traverse

Step 7) Working with AutoMAP

Step 8) Start the First Surface

Step 9) Make the First TIN

Step 10) Start the Second Surface

Step 11) Extract the Second Surface

Step 12) Make the Second TIN

Step 13) Calculate Volumes between the 2 Surfaces

Step 14) Cross Sections across the Job

---

## Starting the Job

To begin, start a new drawing by running the New... command, found under the **File drop-down menu**.

Pick the New button on the Project Manager. Fill in the name of the job and call it **VOLUMES**. Then pick **Save** to continue.

## Setting the Defaults and Toggles

As soon as the job is open you are asked to check or set the General Defaults.

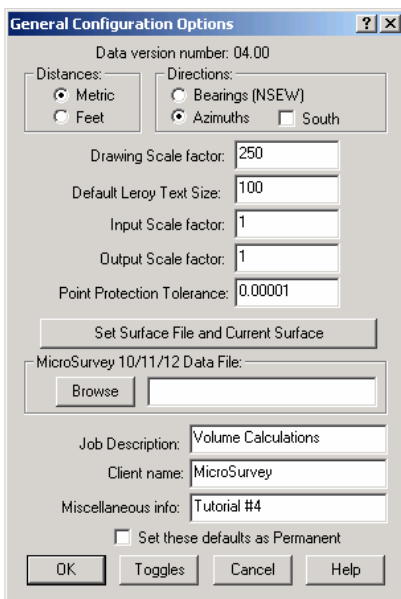

Please take the time to make your General Defaults the same as shown here. Pick the **OK** button to continue.

Now that your job is open, you have many options presented to you. The first set of options are available from the **MicroSurvey Assistant – Main Menu**. This is a floating dialog box with commands on it that you can pick.

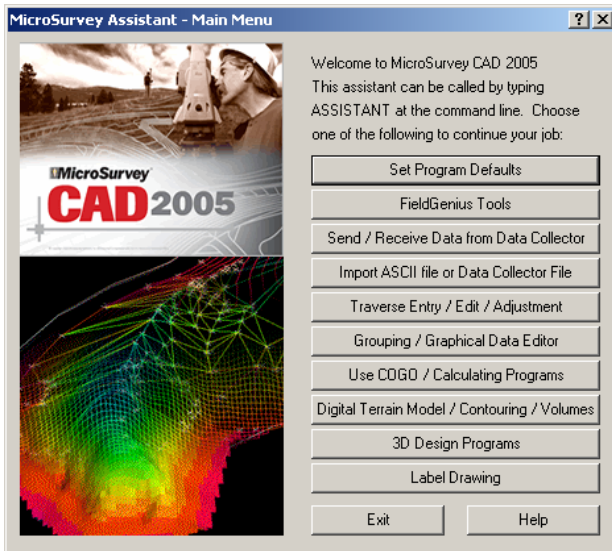

We will go and check and set the program defaults. To do this pick the button **Set Program Defaults**. Next you will be given another dialog box to choose from.

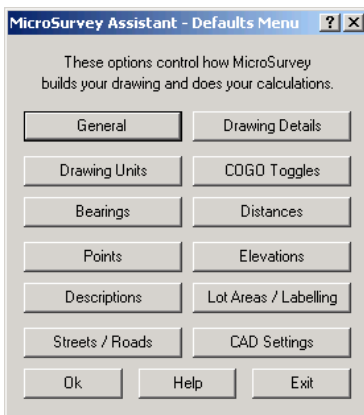

In this dialog box we can choose to set any of the drawing defaults that we may need. In this tutorial we are going to assume that everything we do not look at is considered okay for this job.

We need to check our Toggles so pick the **COGO Toggles** button. This will show you the following dialog boxes. Please make yours look the same as ours shown here. When done pick the **OK** button.



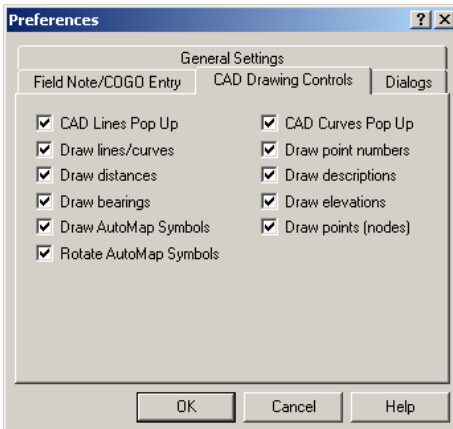
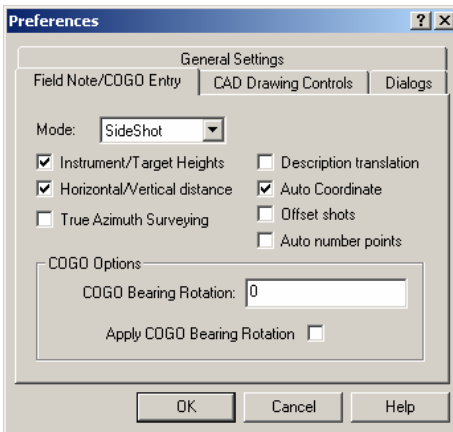
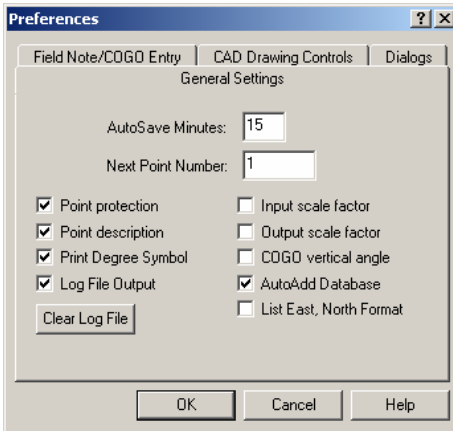

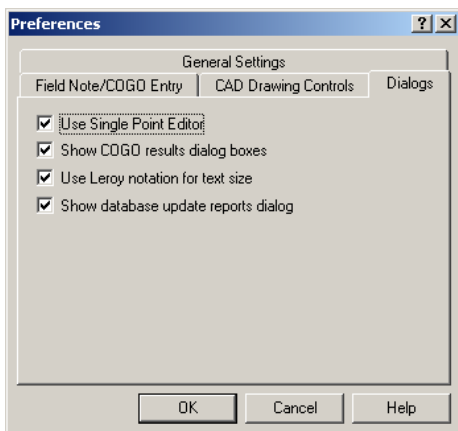

### **System Toggles dialog boxes**

Pick the **OK** button to continue. This will take you back again to the **MicroSurvey Assistant – Defaults Menu**. Press the **OK** button to return to the **MicroSurvey Assistant – Main Menu**.

### **Importing a Data Collector File**

From here we are going to go through the steps to read our data collector file from the hard drive into our program and save it into a traverse file.

Pick on the button labeled **Import ASCII File or Data Collector File**. You will see this next dialog box.

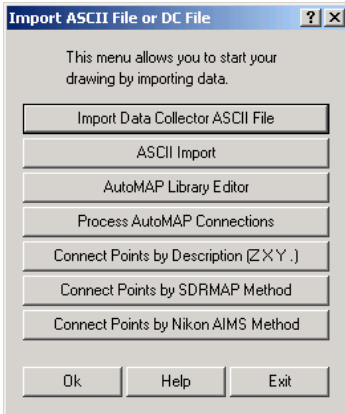

We are going to import a data collector raw file so pick the button labeled **Import Data Collector ASCII File**. This will bring up a dialog box with all the different collector types that we support.

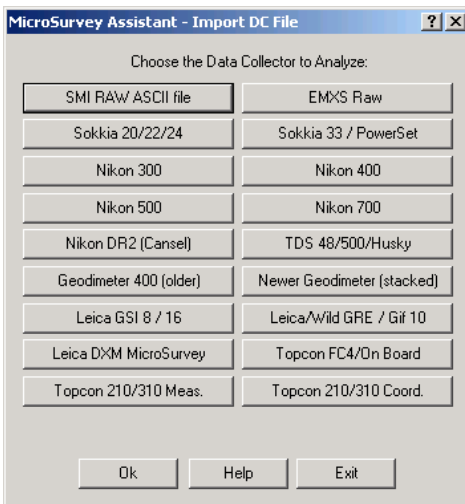

As you can see, the list of supported collector files is very large and includes all the major brands on the market. For this tutorial we will use a file collected in the Topcon format. (This is not saying that Topcon is the collector of choice, only that the file used in this tutorial was of this format. All of the other collector formats would give equally suitable data in this type of job.)

Pick the button labeled **Topcon FC4/On Board (bottom left corner of the dialog)**. As soon as you do you will be presented with the following dialog box;

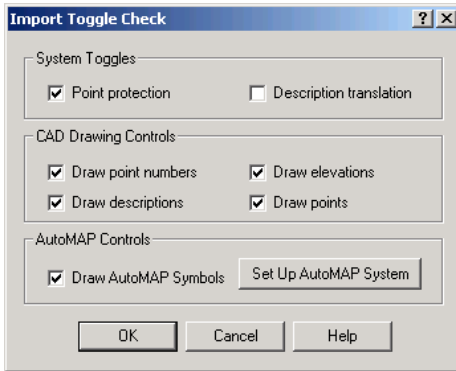

This allows you to quickly check or change your toggles before proceeding. Pick the **OK** button to continue.

You will then be asked to give the file name of the collector file. Go to the **MSCAD 2005TUTORIAL** directory and pick on the file **Fc4-big2.raw**.

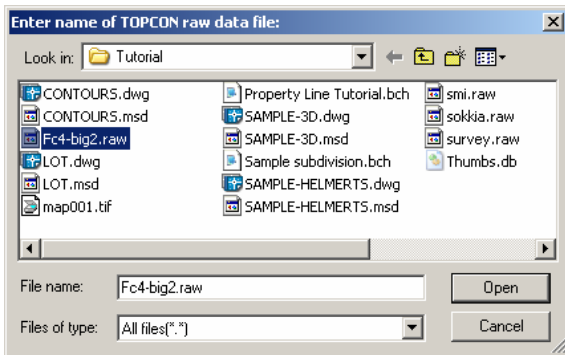

Once you have selected the correct file, press the **OPEN** button to continue.

## Creating the Traverse File

You will then be presented with the dialog box asking if this is a New or Existing Traverse.

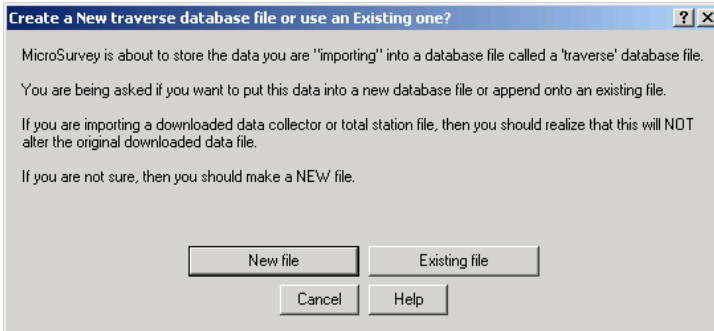

This is a **New Traverse** so pick the New Traverse button. Now you will be asked to name your traverse file. This allows you to have several traverses in one job and keep them all organized so you can work on them separately.

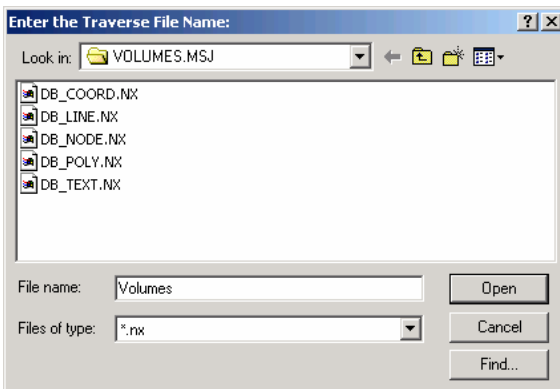

You can name your traverse file anything that makes sense to you. I have chosen the name **VOLUMES** for the traverse. The program will use the project name as the default. Once you have entered the name press the **Save** button.

Next you will be asked to enter some information about this traverse. You may leave this blank if you wish but a good practice is to fill in the information as it is used later in printouts.

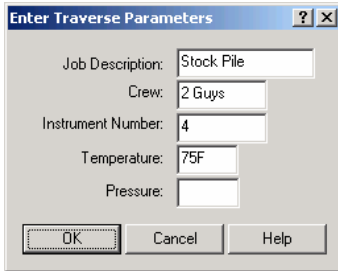

Then press the **OK** button to continue.

From this point, the program very quickly reads the raw data file from the hard drive and stores it into our traverse file. You will see the information scrolling very quickly at the top of the screen in the prompt area. You should see 4 points on the main screen. These were points entered as coordinates in the raw collector file. The rest of the shots have been recorded as raw data and have not been coordinated. We will do that next...

## **Processing and Editing the Traverse File**

You will see this dialog box in the middle of the screen.

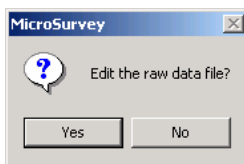

Pick on **YES** so we can see the raw data in the traverse file and confirm that it is correct and complete. If the Assistant is still open, close it down so you can work on the traverse file. You should see the following window with the raw data from the survey.

Job Desc	Crew	Inst Num	Temp	Pressure	Start Date			
Stock Pile	2 Guys	4	75F		10/12/01			
Station	BS Pt	BS Azm	BS Read	Inst Ht				
1	2		180°00'00"	1.560				
Shot Pt	Trgt Ht	Hz Ang	Vt Ang	Slp Dist	Desc	North	East	Elev
2	1.450	180°00'00"	99°59'50"	71.938	NL	4929.154	5000.000	87.622
5	1.450	340°23'10"	95°47'55"	125.156	NL	0.000	0.000	0.000
118	2.100	181°35'55"	120°08'10"	23.280	BOTTOM	0.000	0.000	0.000
119	2.100	187°53'30"	113°03'00"	30.130	BOTTOM	0.000	0.000	0.000
120	2.100	191°40'05"	109°01'50"	36.320	BOTTOM	0.000	0.000	0.000
121	2.100	189°59'35"	105°40'55"	43.510	BOTTOM	0.000	0.000	0.000
104	2.100	181°41'25"	120°07'00"	23.290	TOP	0.000	0.000	0.000
105	2.100	159°42'50"	117°06'30"	20.950	TOP	0.000	0.000	0.000
106	2.100	136°51'45"	115°24'45"	19.860	TOP	0.000	0.000	0.000
107	2.100	115°52'50"	118°09'50"	20.660	TOP	0.000	0.000	0.000
108	2.100	100°37'25"	122°56'05"	19.980	TOP	0.000	0.000	0.000
109	2.100	79°40'25"	111°38'25"	20.450	TOP	0.000	0.000	0.000
110	2.100	51°03'50"	116°53'20"	20.820	TOP	0.000	0.000	0.000
111	2.100	36°34'40"	120°22'30"	22.650	TOP	0.000	0.000	0.000
117	2.100	36°34'40"	120°22'30"	22.640	BOTTOM	0.000	0.000	0.000
116	2.100	31°43'20"	117°00'35"	24.980	BOTTOM	0.000	0.000	0.000
115	2.100	16°47'55"	112°03'20"	30.570	BOTTOM	0.000	0.000	0.000
114	2.100	15°07'15"	109°53'05"	33.590	BOTTOM	0.000	0.000	0.000
113	2.100	9°27'10"	108°19'40"	36.070	BOTTOM	0.000	0.000	0.000
112	2.100	356°26'25"	106°18'35"	40.280	BOTTOM	0.000	0.000	0.000
103	5.000	346°38'20"	101°22'35"	42.950	BOTTOM	0.000	0.000	0.000
102	6.000	335°34'25"	98°29'40"	48.280	BOTTOM	0.000	0.000	0.000
101	6.000	333°16'20"	97°47'15"	52.640	BOTTOM	0.000	0.000	0.000

## Coordinate the Traverse

Select Re-coordinate Traverse from the Edit Menu on the Active Drawing Editor. Or you can type Ctrl-R if the editor window is current.

You will be given the option of creating a Recoordination Report or Log. Accept the defaults as shown:

**Recoordination Report (Log)** [?] [X]

Multiple Shots Option

Let me choose the shots       FS Shots Report  
 Choose Very Last Shot as the Correct Shot  
 Average multiple shots

Point Protection Status : DN

BS and VA check routine

Back Sight (BS) Check       Vertical Angle Check

Dist. Tolerance (m / feet)

Angle Tolerance (dms)

---

Now you will see the coordinates being calculated in the prompt area on top of the screen as well as the information being drawn into the graphics window. The entire job will be imported and displayed on screen.

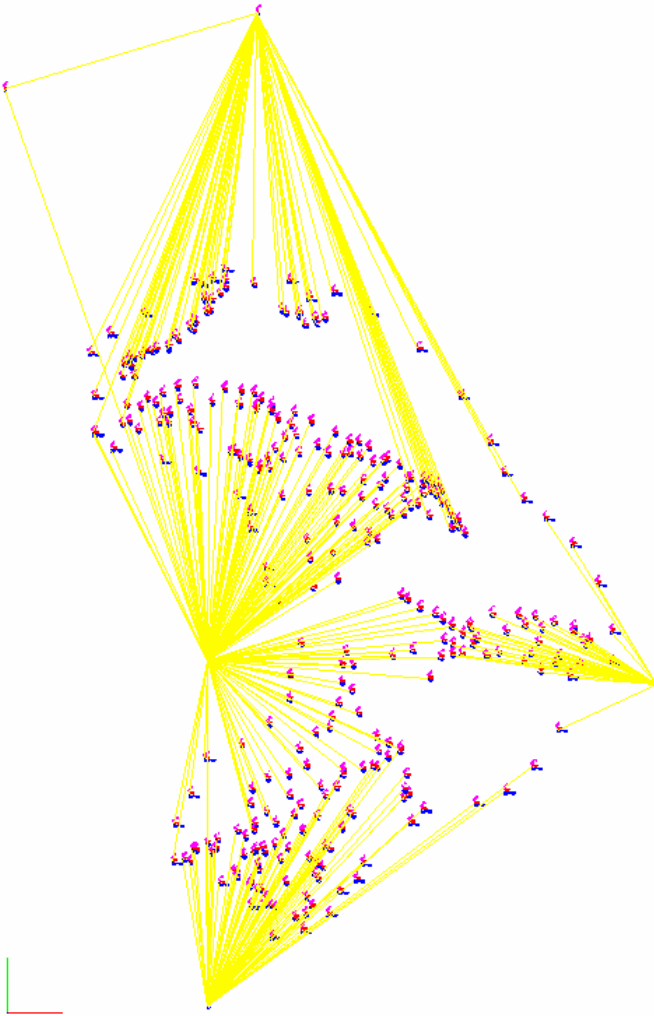

The linework you see is only temporary and will be erased as soon as you do a zoom command or a redraw command. You will be left with nothing but the points at that time. To be able to do a zoom or redraw command we have to exit out of the MicroSurvey Assistant menus. Press the **OK** button and then the **EXIT**



---

button to get out of the assistant. Then do a **Zoom Fit** (zoom extents) by picking this button on the left of the screen.



You will now see the points as shown below.

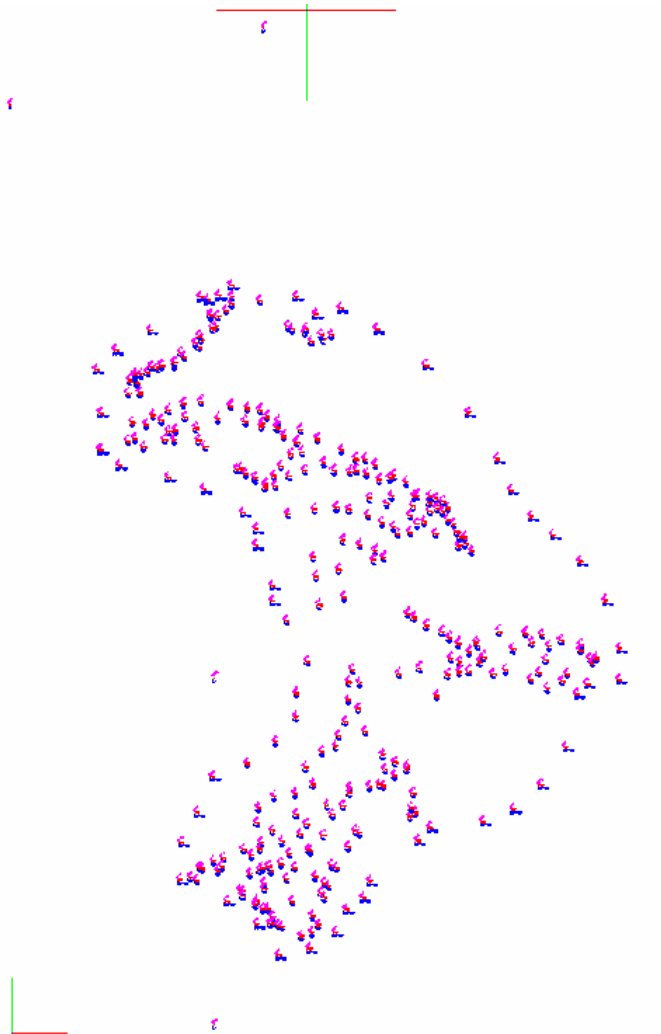

### Working with AutoMAP

---

Our objective is to calculate the volume of this pile of earth. To do this we need to layer separate the data to help us build the two surfaces. In other words we want all the points with descriptions of TOP to be on one layer and the points with descriptions of BOTTOM on a different layer. This will make it easier to select the correct points to create surfaces to generate volumes.

To do this we are going to use the AutoMap program. You can find this in the **MsTraverse pulldown | Automap System**. This command is available in other locations as well.

This will display the dialog box below.

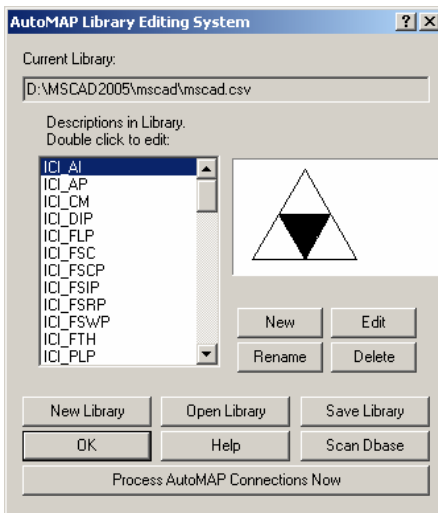

This is a powerful command but we will just use a portion of it's power in this tutorial. First thing you need to do is pick the **New Library** button. This will remove the current listing of descriptions (which do not match our current job) and allow us to then pick the **Scan Dbase** button which will go to our job and look up every description we used and display them, ready for editing.

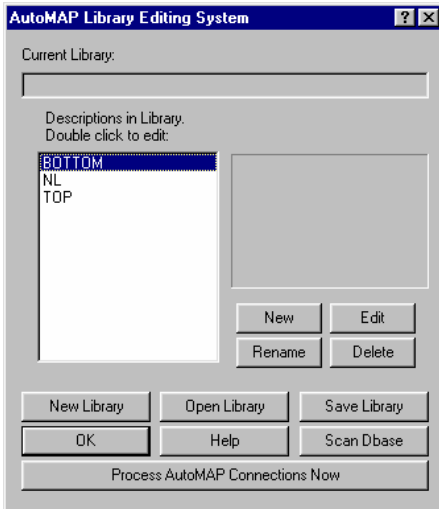

This job has 3 different descriptions. BOTTOM, TOP and NL. We do not need the NL description as it only defined the control points and is not related to the surfaces we are creating, so we are going to delete this description from our list. This will not erase the points for the job. It only means that the points will not be relocated to another layer or have linework connecting them, so do not worry. Pick the description **NL** from the left side of the dialog and then pick the **Delete** button.

You will be asked if you are sure that you wish to delete this description.

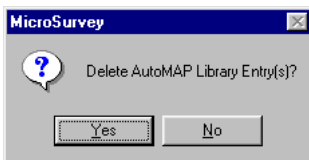

Pick the **YES** button to continue.

This will leave you with only the BOTTOM and TOP descriptions to be edited. Now pick on the description BOTTOM and pick the **Edit** button. You will now see this dialog box.

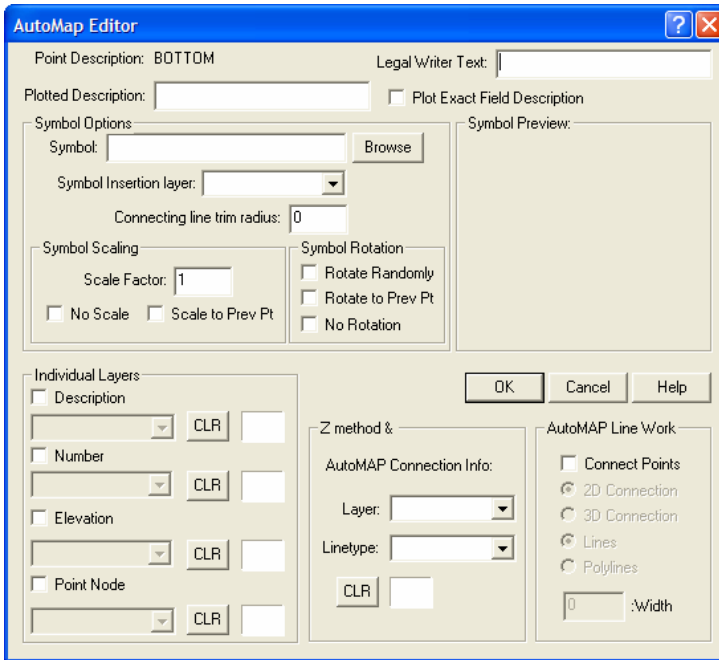

This dialog box has many options on it. The ones we are concerned with are in the bottom half. Set your program to match the dialog below. We are not applying any symbols, but we are going to draw a 3D polyline connecting all the points with the description Bottom, in increasing point number order. We are also moving the nodes, elevations and point numbers to the same layer as the description and polyline. **Note: Set the layer color to Red.**

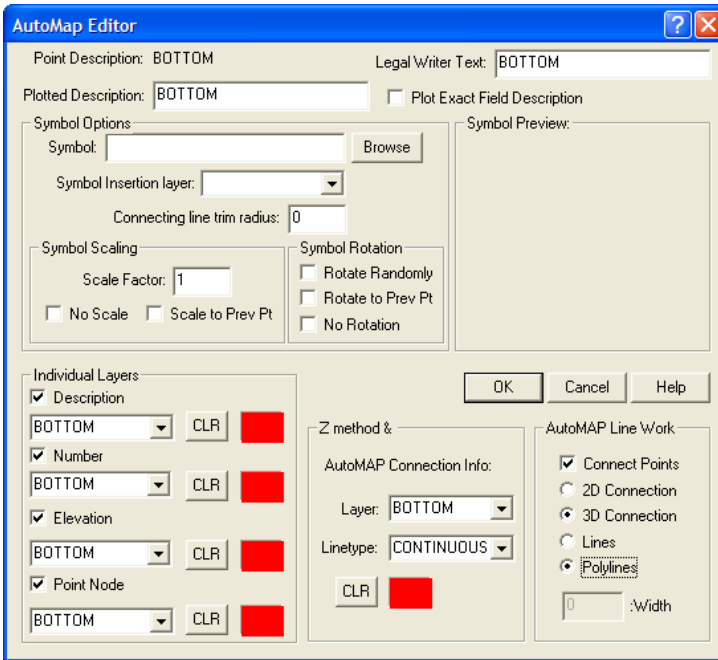

When you have set all the options as above then press the **OK** button and edit the description TOP in the same method. The settings are shown below. **Note:** Set the layer color to Blue.

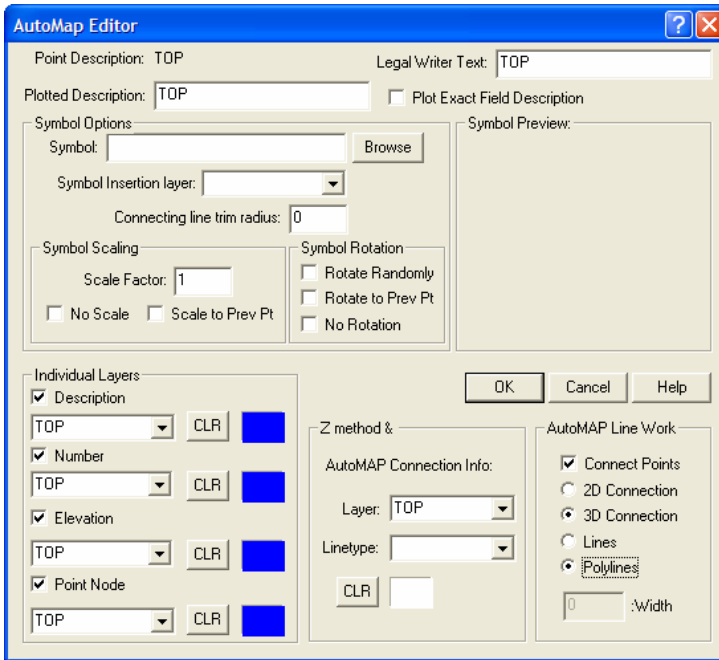

Pick the **OK** button after setting the above dialog.

Lets save this library for future use. Pick on the **Save Library** button.

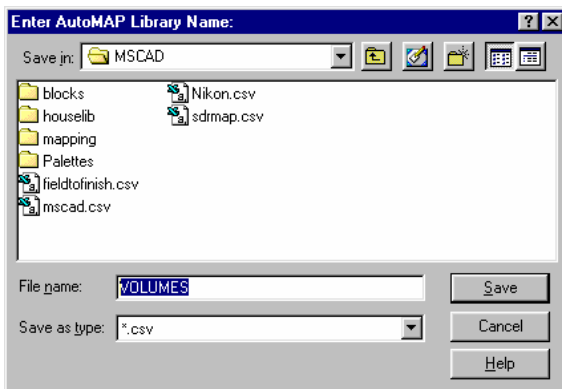

Give the library a unique name of **VOLUMES**, as shown above. Pick the **SAVE** button to continue.

---

Now all that is left is to process the settings for the descriptions. Press the **Process AutoMAP Connections Now** button.

Now you will see the following dialog box;

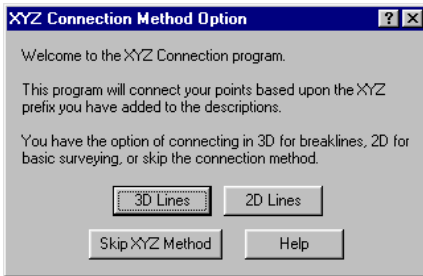

Because we are not using the Z-Coding option in this example, simply pick on the **Skip XYZ Method** button to continue.

Using the Explorer we will freeze the layers shown below by picking on the **layer names** to highlight them. Pick the **“Thawed”** word as shown below to toggle the value to **“Frozen”** to freeze the layers – lastly, exit the Explorer.

Layers settings in drawing - [D:\Jobs2005\WOLUMES.dwg]

Layer Name	Color	Linetype	On/Off	Locked	All Viewports
✓ 0	255	Continuous	On	No	Thawed
BOTTOM	red	Continuous	On	No	Thawed
DESCRIPTION	cyan	Continuous	On	No	Frozen
ELEVATION	yellow	Continuous	On	No	Frozen
MSPOINT	white	Continuous	On	No	Frozen
POINTNUMBER	cyan	Continuous	On	No	Frozen
TOP	blue	Continuous	On	No	Thawed

Now your job should look like this.

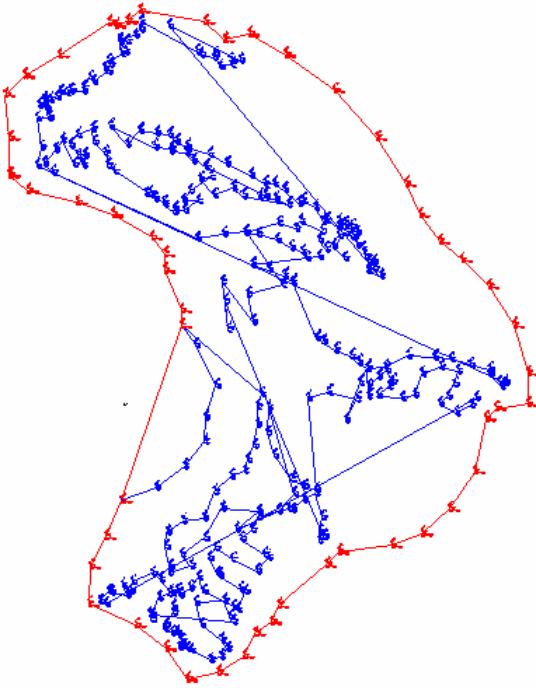

The Bottom points have all been placed on the BOTTOM layer and connected by a 3D Polyline and the Top points have all been placed on the TOP layer and connected separately by another 3D Polyline.

### Start the First Surface

Now we are ready to generate 2 surfaces to calculate volumes from. The first surface will have all of the Top and Bottom points to define the upper surface of the pile.

To do this we will load the palette from the MsModeling pulldown menu by picking on the option **Modeling Palette....** The following palette (toolbox) will appear on screen. Move it to a convenient location on the right of the screen.





---

To extract points to a surface, **pick this button.**



The following dialog box will appear. Please fill it out as shown below and then pick the **OK** button to continue.

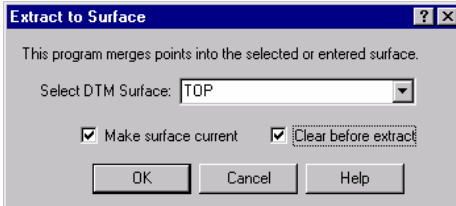

After picking the OK button you will be asked to select all the points to be used in this surface. We need all of the points on screen to form the top surface so **simply press the ENTER button to select them all.**

It should report in the command prompt area;

```
727 points total in surface.
```

We have now defined the surface by extracting the points, but we now also need the breaklines to add more detail and make the surface accurately reflect the surface edges of the pile.

To extract the breaklines to the same surface, **pick this button.**



The following dialog box will appear. Please fill it out as shown below and then pick the **OK** button to continue. **Note: remove the Clear before extract checkbox!**

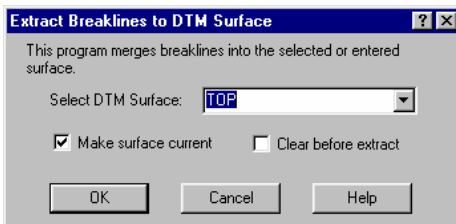

After picking the OK button you will be asked to select all the breaklines to be used in this surface. We need all of the linework on screen to help form the top surface so **simply press the ENTER button** to grab them all. You should see something like this on the text screen:

---

2 Break Lines extracted  
337 stacked points dropped,  
Auto densification...  
756 triangles built  
1206 triangles built  
1308 triangles built  
1348 triangles built  
1372 triangles built  
1386 triangles built  
1398 triangles built  
321 additional points added to current surface

### **Make the First TIN**

Next we need to create a TIN for this surface. **Pick this button.**  from the palette.

The TIN command will ask you several questions. Answer them as follows;

Surface name <TOP>: **<Enter>**

None/Show/Draw/Redraw <Show>? **<Enter>**

This will temporarily display the TIN so we can confirm that the TIN has been generated correctly.

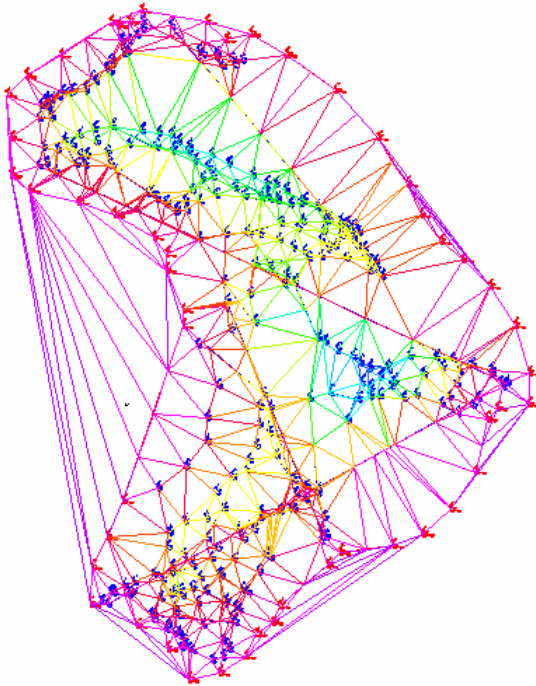

A redraw or zoom command will remove the TIN from the screen.

### **Start the Second Surface**

Now we need to create the Bottom surface. It is difficult to pick the points around the outside edge of the pile without accidentally picking other points as well, so we will isolate the bottom layer on screen. This command can be found on the **MsTools** → **Layer Control Tools** then pick the **ISOLATE** option.

After the command load you will be asked to:

Select item on layer to isolate: **Pick on one of the red lines, then press <ENTER>**

Now the job should look like this:

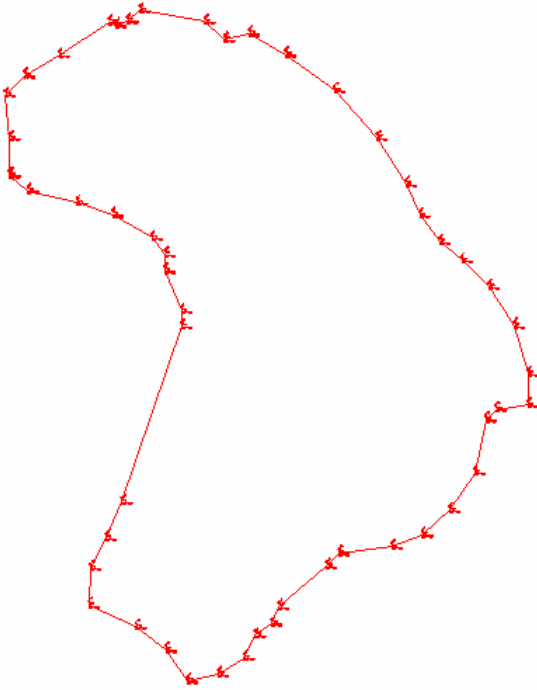

### Extract the Second Surface

To extract the points to a new surface, **pick this button.**



The following dialog box will appear. Please fill it out as shown below and then pick the **OK** button to continue.

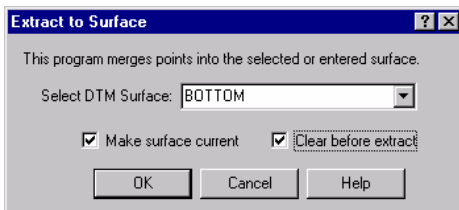

After picking the OK button you will be asked to select all the points to be used in this surface. We need all of the points on screen to form the bottom surface so **simply press the ENTER button** to grab them all.

It should report in the command prompt area;

---

117 points total in surface.

So far we have the points that help define the surface but we now also need the breaklines.

To extract the breaklines to the same surface, **pick this button.**



The following dialog box will appear. Please fill it out as shown below and then pick the **OK** button to continue. **NOTE: Remove the Clear before extract check box.**

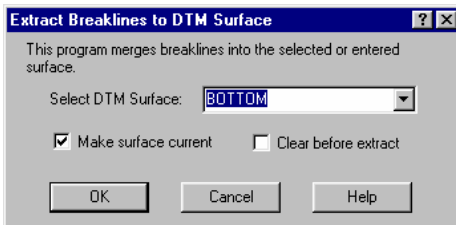

After picking the OK button you will be asked to select all the breaklines to be used in this surface. We need all of the linework on screen to help form the bottom surface so simply press the ENTER button to select them all.

### **Make the Second TIN**



Next we need to create a TIN for this second surface. **Pick this button.** from the palette.

The TIN command will ask you several questions. Answer them as follows;  
Surface name <BOTTOM>: **<Enter>**

None/Show/Draw/Redraw <Show>? **<Enter>**

This will temporarily display the TIN so we can confirm that the TIN has been generated correctly.

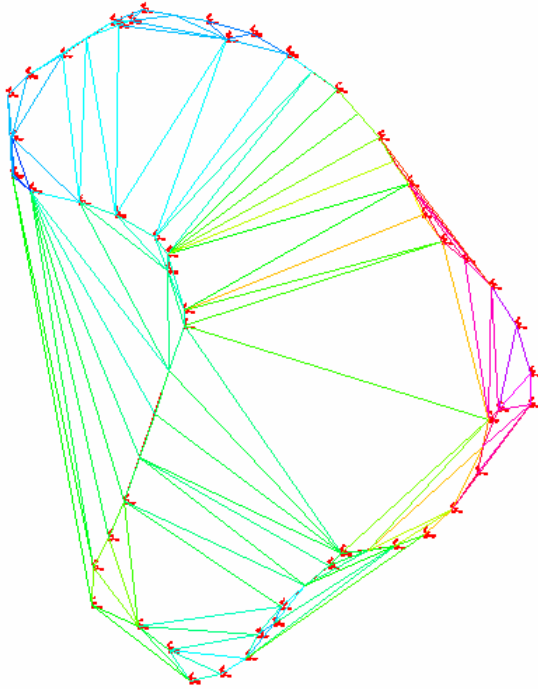

A redraw or zoom command will remove the TIN from the screen.

### Calculate Volumes between the 2 Surfaces

Now we can finally calculate the volume between the surfaces called TOP and BOTTOM.

We can calculate the volume in two different ways. First we will run the **Surface Volume** command from the **MsModeling pulldown menu** → **Volumetrics**.

Fill out the two surface names as shown with the **TOP** surface on the left and the **BOTTOM** surface on the right. Be sure to pick the check box beside Surface Name to be able to enter the BOTTOM surface

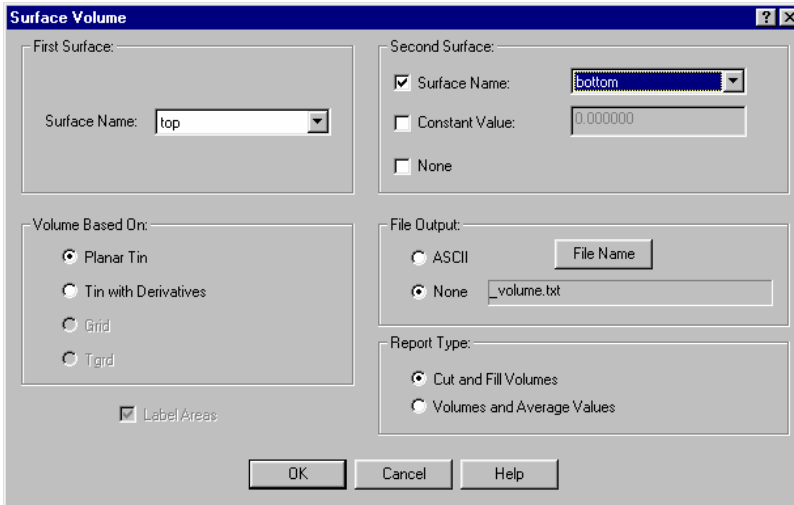

Now pick the **OK** button and volumes will be calculated and displayed in the command prompt area on screen. Flip to the command prompt window by pressing the **F2 function key** (a second time to return to the normal screen)

The volume will be displayed like this.

Using conversion factor of 1.

Volume of TOP-BOTTOM based on a planar tin.

Positive Volume	Negative Volume	Net Volume
-----	-----	-----
46522.834	46522.834	-3.449e-005

The negative volume shown here is so small that it does not affect the job in any way and was due to minor deviations in the way the two TINs were generated. Your final volume is 46,522.834 m<sup>3</sup> (because our job was in metric – if it had been feet then the units would have been cubic feet by default)

The Second way to calculate the volumes between the same two surfaces is the Area Volume command.



Run the Area Volume command by **picking this button** from the palette.

---

Fill out the surfaces in exactly the same way as we did above for the Surface Volume command. Pick **OK** to continue.  
Now for the slight difference between the two methods. You are now prompted...

Select area polygons:  
Return to select all visible or  
Select objects: **Pick the RED polyline around the bottom of the pile and press <enter>**

(**NOTE:** When doing one of your real jobs instead of this tutorial – the polyline around the base may not be created properly with the AutoMAP command due to the order the points were picked up in, in the field. You may find that you have to manually draw a polyline from point to point instead.)

The polyline you pick now is the one that we drew with AutoMAP, around the base of the pile.

The volume report will be the same – confirming that we have the correct answer.

Using conversion factor of 1.

Volume of TOP-BOTTOM based on a planar tin.

Area	Positive Volume	Negative Volume	Net Volume
----	-----	-----	-----
	46522.834	-3.449e-005	46522.834

Area 1 will also be labeled on the drawing.

### **Cross Sections across the Job**

For those who wish to confirm the volume by seeing cross sections to prove the answer, we have just the feature to do this.

Under the **MsDesign pulldown menu** → **AutoRoute** options there is a command **Across Full Surface**.

You will be asked which surface you wish to plot. Select **TOP** and press **OK**.



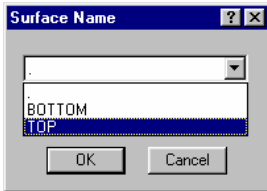

Next you will be asked which way do you wish to run the center line for all the cross sections to be related to. Then you will be asked for the Interval for the cross sections.

Begin on which side of surface North/South/East/<West>: **N**  
<Enter>

Enter cross section interval: **20**

A center line and cross section lines will be drawn over the job as reference.

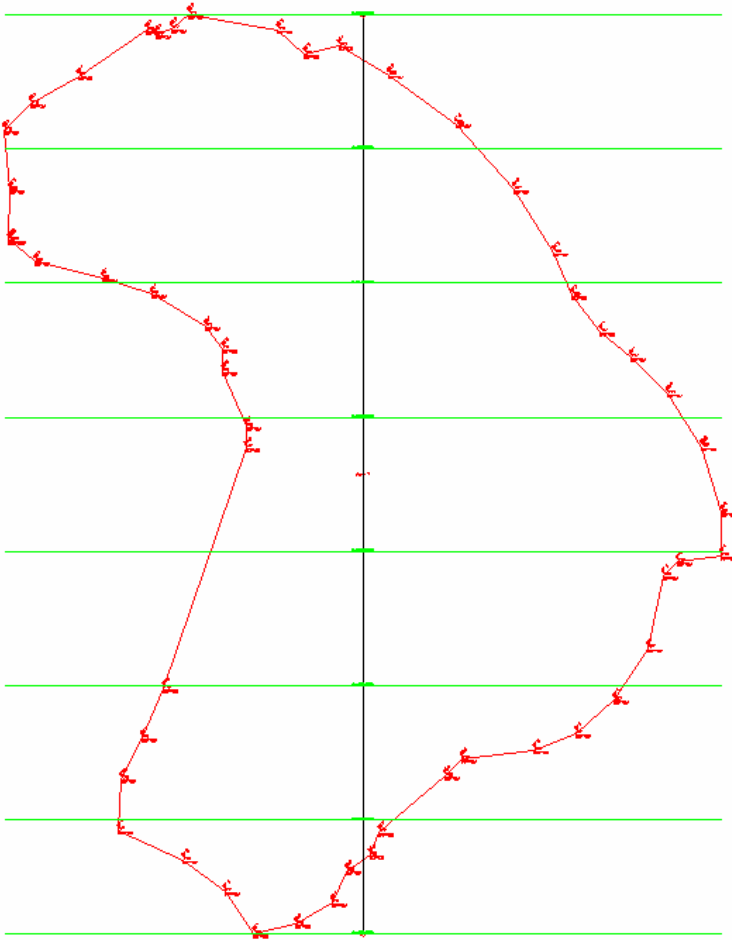

If you wish, you can erase these lines, or leave them for later reference. Your choice!

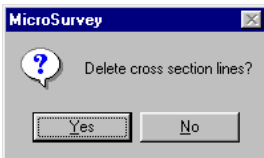

I left them on in my example by answering NO.

Next you will be asked if you wish to plot the cross sections.

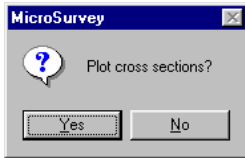

Answer **Yes** to this and you will get the following dialog box that controls the grid on the cross sections.

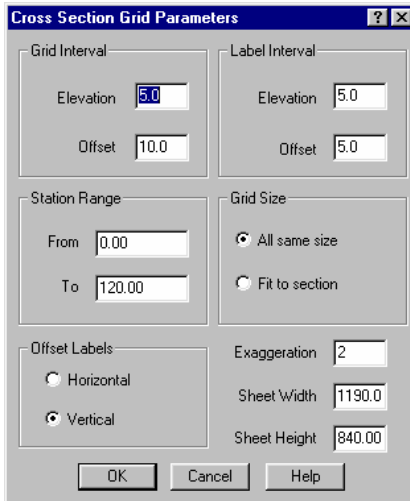

Fill your dialog box out as shown above and when completed press the **OK** button. Note: This job is a Metric job, so the width and height of the sheet are in mm. If you were working in feet, you would put in the inch size of the paper you were using, like 24 x 36

. When you pick the Ok button, You will be prompted with:

Pick lower left corner: This is the insertion point for the cross sections so select a starting point over to the right of the diagram so they do not overlap each other.

Below is one of the cross sections enlarged.

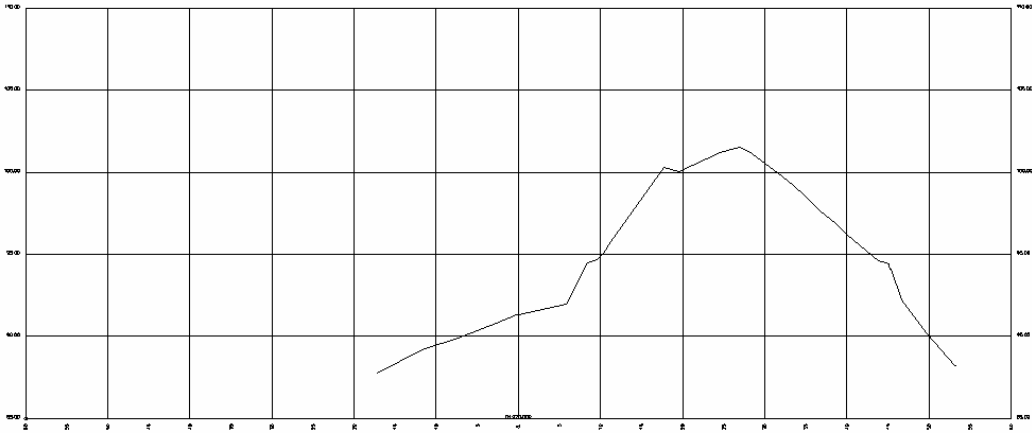

You can change the color of the layers to get better visual results or for setting pen widths for plotting.

As a double check you can calculate the volume under the cross sections, to work out the volume the old hand method.

Save your job by picking the **SAVE** command from the File pulldown menu. Then be sure to save your surfaces, as you were shown in the Data Collector Tutorial.

(End of tutorial)

---

## Road Design Tutorial

Because of the size and complexity of this tutorial we have broken it down into 9 smaller steps to make it easier for you to follow.

Step 1) Opening the Job

Step 2) Create the Ground Surface

Step 3) Inputting the Horizontal Alignment

Step 4) Stationing and Saving the Horizontal Alignment

Step 5) Create Profile

Step 6) Design New Profile

Step 7) Create Cross Section Template

Step 8) Create New Road Surface

Step 9) Output Cross Sections

### **Opening the Job**

Start by opening the CONTOURS.DWG file using the Open command found in the File menu. The CONTOURS.DWG file should reside in your \MSCAD 2005\TUTORIAL directory by default. You will need to change the Project Manager -> Project Directory to point to the Tutorial directory, or you can copy the CONTOURS.DWG file to the \JOBS2005 directory and open it there.

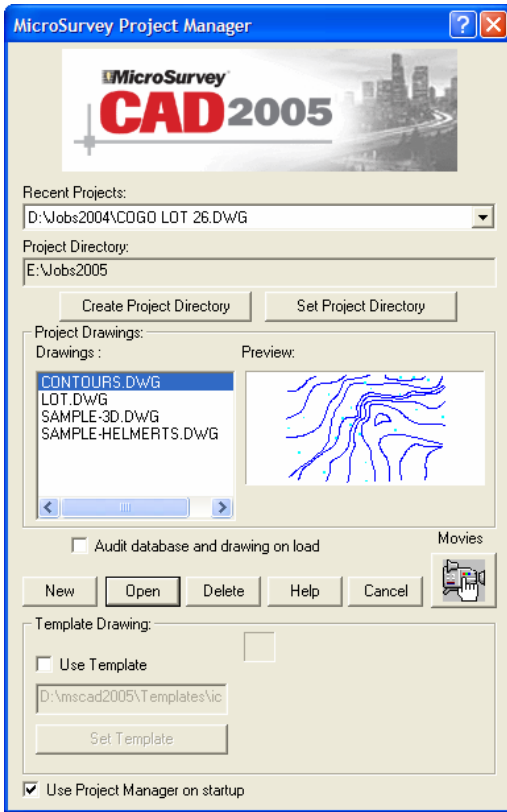

Pick on the job name and then pick the **Open** button.

The system General Configuration Options should be set to match the following for this job to work cleanly. Press the **OK** button once they are confirmed to be correctly set.

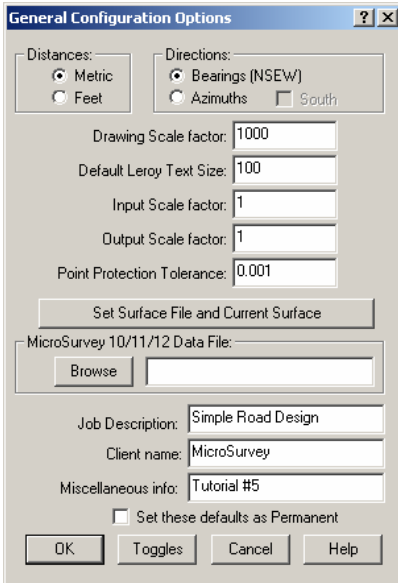

**Exit** out of the **MicroSurvey Assistant** if it comes up on screen. We will not need this excellent tool for this tutorial.

You will see a series of contours and a few points, they will be used to define your existing surface.

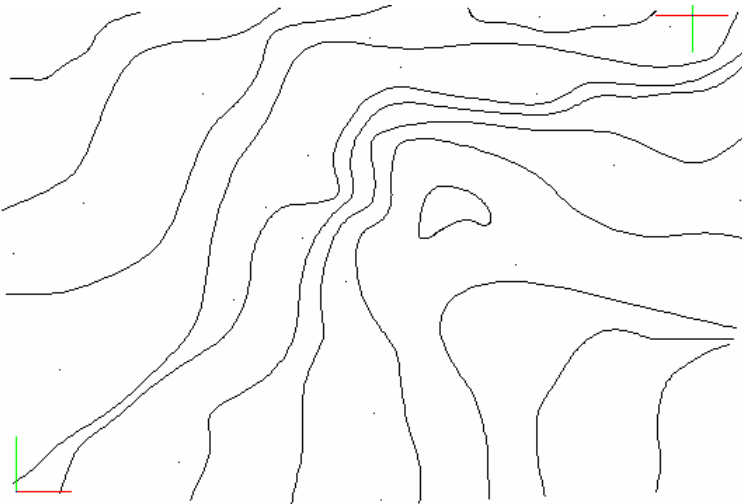

---

## Create the Ground Surface

Do the **SAVEAS** command to create a new drawing using the contours as a starting point. This will protect the original data so you can execute the tutorial again if you wish.

Type **SAVEAS** and press **enter**, or go to the File drop-down menu and pick on the **SAVE AS...** command..

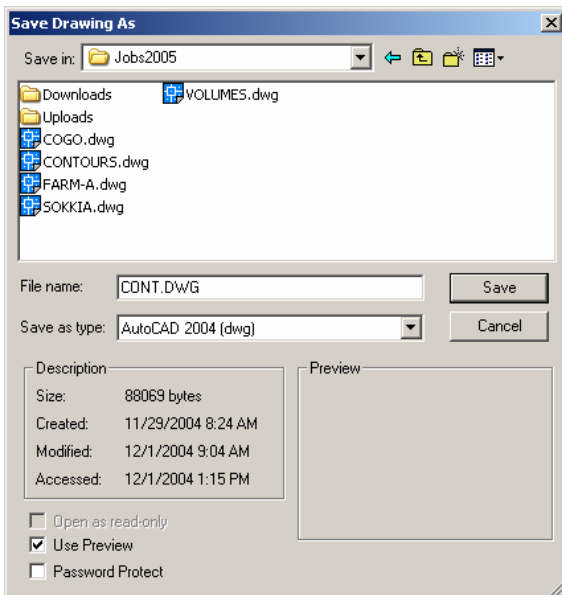

Change the default folder to save in **JOBS2005** and change the file name to **CONT.DWG** then pick the **SAVE** button to continue.

Next, we need to extract all of the 3D point data and 3D breaklines (contours) to create the existing surface.

To do this we are going to control what is on screen by isolating the points and the breaklines on screen, one at a time. Under the **MsTools pulldown menu -> Layer Control** pick the **ISOLATE** option.

Select item on layer to isolate: **(pick on one of the points and press Enter)**  
Now all you will see on screen are the points.

Next we will load the Modeling palette from the **MsModeling pulldown menu** by picking on the option **Load Modeling Toolbox**. The following palette (toolbox) will appear on screen. Move it to a convenient location on the right of the screen.





To extract points to a surface, **pick this button.**



The following dialog box will appear. Please fill it out as shown below and then pick the **OK** button to continue.

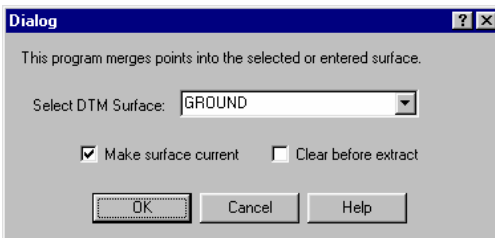

After picking the OK button you will be asked to select all the points to be used in this surface. We need all of the points on screen to form the top surface so simply press the ENTER button to grab them all.

It should report in the command prompt area;  
21 points total in surface.

So far we have the points that help define the surface but we now also need the breaklines.

Under the **MsTools pulldown menu -> Layer Control** pick on the **UNISOLATE** option, this brings back the breakline layer. Now Under the **MsTools pulldown menu -> Layer Control** pick the **ISOLATE** option.

Select item on layer to isolate: **(pick on one of the breaklines (contours) and press Enter)** Now all you will see on screen are the breaklines (contours).

To extract the breaklines to the same surface, **pick this button.**



The following dialog box will appear. Please fill it out as shown below and then pick the **OK** button to continue.

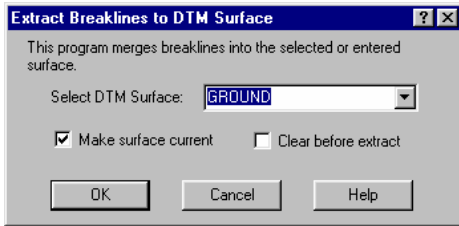

After picking the OK button you will be asked to select all the breaklines to be used in this surface. We need all of the linework on screen to help form the top surface so simply press the ENTER button to grab them all.

Next we need to create a TIN for this surface. **Pick this button.**  from the palette.

The TIN command will ask you several questions. Answer them as follows;

Surface name <GROUND>: **<Enter>**

None/Show/Draw/Redraw <Show>? **<Enter>**

This will temporarily display the TIN so we can confirm that the TIN has been generated correctly.

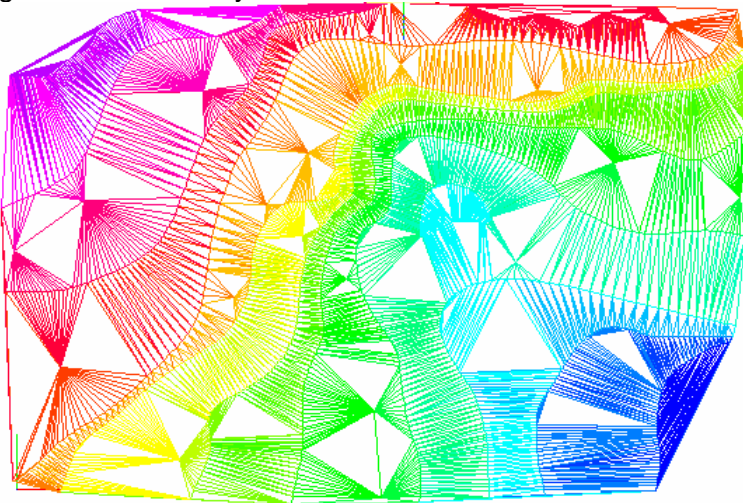

A redraw or zoom command will remove the TIN from the screen. The Tin will remain in memory.

---

## **Inputting the Horizontal Alignment**

Now that we have our surface we can create our alignment.

Start by going to the **MsDesign pulldown menu -> AutoRoute** and picking the **Design Alignment** command.

In the Command prompt area, it will ask you the following, please enter the information shown:

Enter alignment name: **MAPLE**

\* NOTE \*

When naming a horizontal alignment, be sure to use only a single word, with no spaces, as the name, such as:

ROAD1, Orange\_Side\_Road, Maple\_Street, Pine-Street, Maple

From point: **-200,100**

To point: **1,90**

To point: **70,-45**

To point: **240,-50**

To point: **<Enter>**

Note: It is not necessary to enter exact coordinate to create an alignment. You can also "pick" the points on screen.

The center line of the road is now drawn.

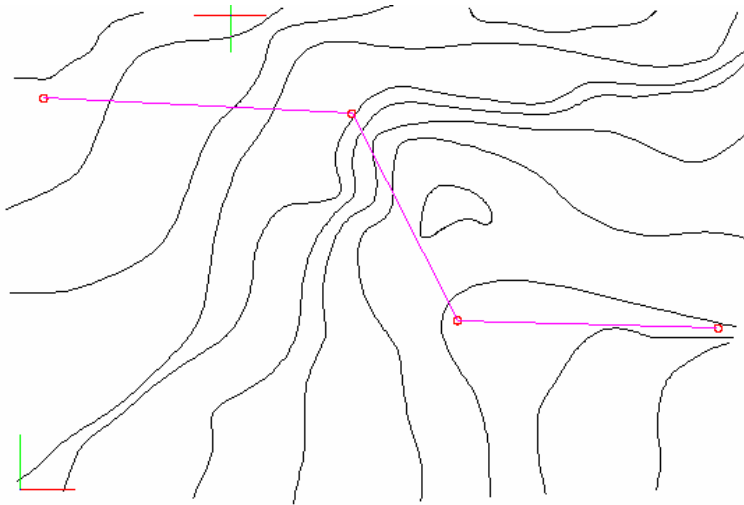

Next you will be asked if you wish to edit the alignment:

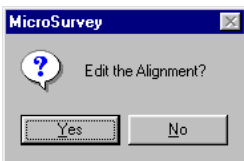

Answer **Yes** so we can insert new curves and spirals.

Edit alignment. Add/Delete/Move/Curve/SCS: **SCS**

Pick POT: **<pick the red circle at the FIRST bend in the road>** (zoom in if you can not pick it easily. Don't miss it!)

Now you will see the following dialog box.

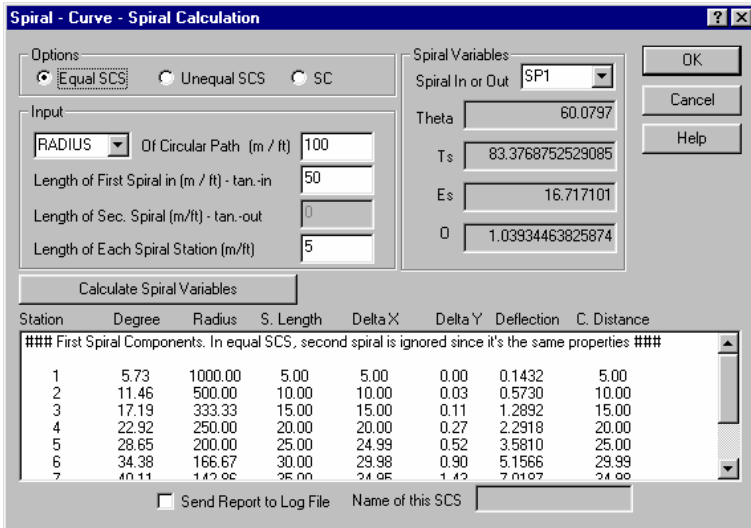

Fill in the top left corner of the dialog, as shown above, and then pick the **Calculate Spiral Variables** button to calculate the rest of the fields in the dialog box. Pick the **OK** button to place the spirals and curve on the screen.

Pick POT: **<Enter>**

Edit alignment. Add/Delete/Move/Curve/SCS: **Curve**

Pick POT: **<pick the red circle at the SECOND bend in the road>** (zoom in if you can not pick it easily. Don't miss it!)

Enter curve radius: **50**

Pick POT: **<Enter>**

Edit alignment. Add/Delete/Move/Editcurve/Newcurve: **<Enter>**

Now you will be asked if you wish to continue and profile the existing ground surface?

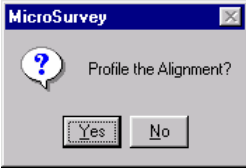

Pick **NO** for now.

At this point your job should look like this:

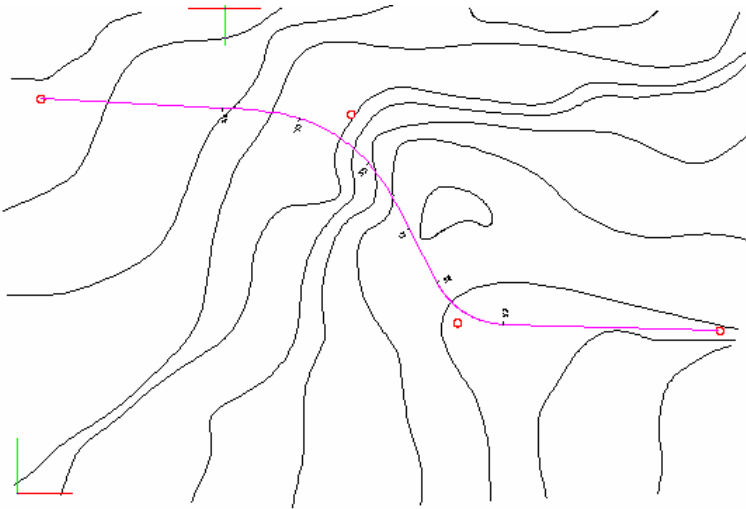

### Stationing and Saving the Horizontal Alignment

Before we continue with the profile lets label the stationing along the alignment. Go to the **MsDesign** pulldown menu -> **AutoRoute** pick on the **Label Alignment** option

Label alignment. Stations/Offsets/NewPoint/ExistingPoints/Report: **STATIONS**

There are many options to label and create points along the alignment and on offsets, as well as reports.

We are going to simply label points along the centerline in this example.



Pick **OK** to continue

After picking Stations as the method you will have the following dialog box appear:

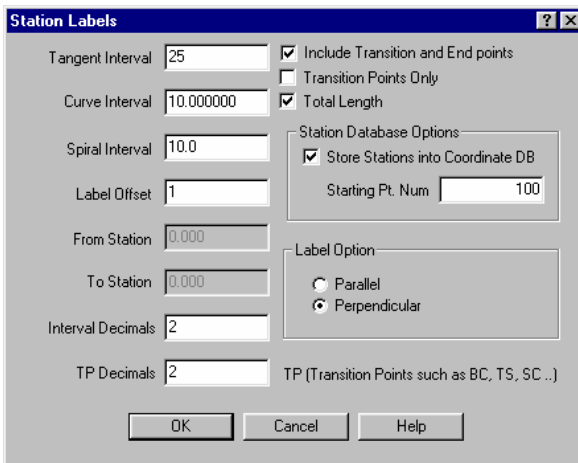

Fill in the dialog as shown and pick **OK** to continue.

Label alignment.

Stations/Offsets/NewPoint/ExistingPoints/Report: **<Enter>**  
to continue

Here is what you will see on screen,

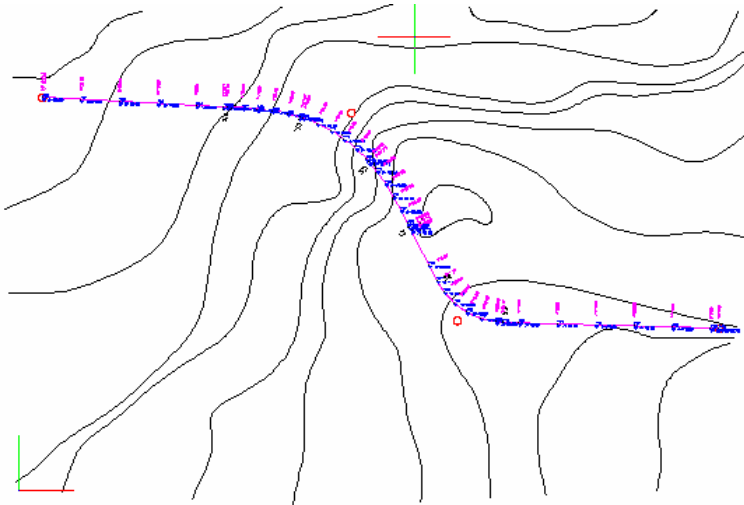

and a close up showing the labeling,

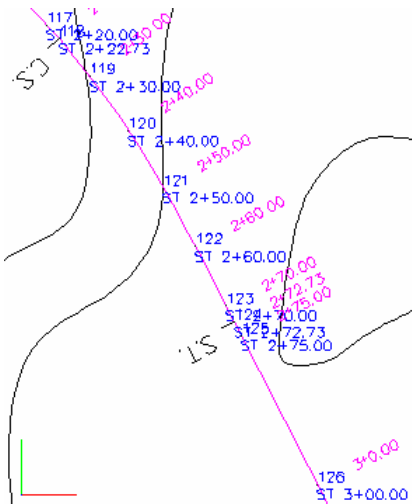

You can see that the tangent, curve and spiral have had the stationing labeled, as well as the beginning of Curve and Spiral. New points have been created along the centerline with the description set as the station. Some text overlap is apparent and a simple move command can clean this up.

Now we should save this alignment to a file to protect us and allow us to retrieve it without having to recreate it from scratch.



---

Under the **MsDesign pulldown menu -> AutoRoute** pick on the **Write .HRZ File** option.

On the command prompt window you will see the message that tells you where and what the file is called.

```
Alignment saved in C:\Jobs2005\MAPLE.HRZ.
```

### Create Profile

Now that we are finished labeling and saving the horizontal alignment – lets continue with the vertical profile.

Go to the **MsDesign pulldown menu -> AutoRoute** and pick the **Extract Existing Ground Profile** option.

You will be asked to pick from a list of surfaces – we want GROUND as our surface.

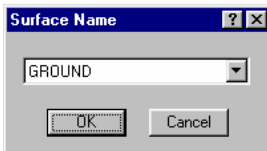

Pick on the word **GROUND** and pick the **OK** button.

Next you will be shown a dialog box that will control how the profile will be drawn.

Change the settings to match this dialog:

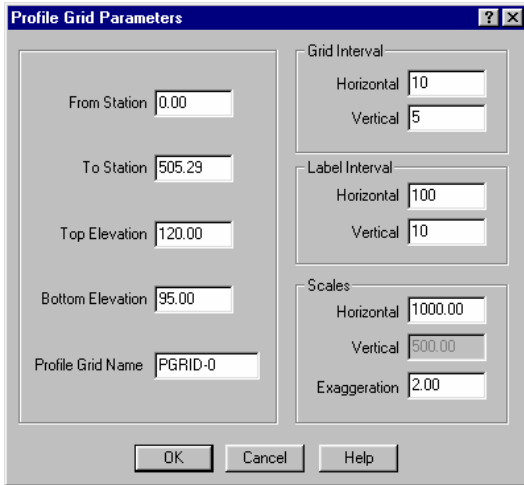

The only value you need to change is the Grid Interval Horizontal from **100 to 10**. Press the **OK** button to continue. Next you will be asked:

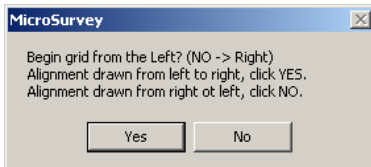

Pick **YES** to continue

Pick lower starting corner of grid: **<Pick Somewhere Appropriate – maybe Above the Alignment>**

You will be asked if you wish to create the design profile?

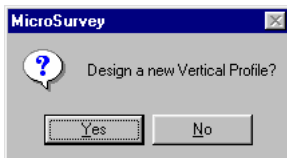

Answer **NO** for now.

Now lets set the Profile\_Grid layer to gray (color 9) for easier visibility, Go to the Layer Manager (View menu, Layer Manager... command). Then pick on the layer, as shown, and change the color to gray(9).

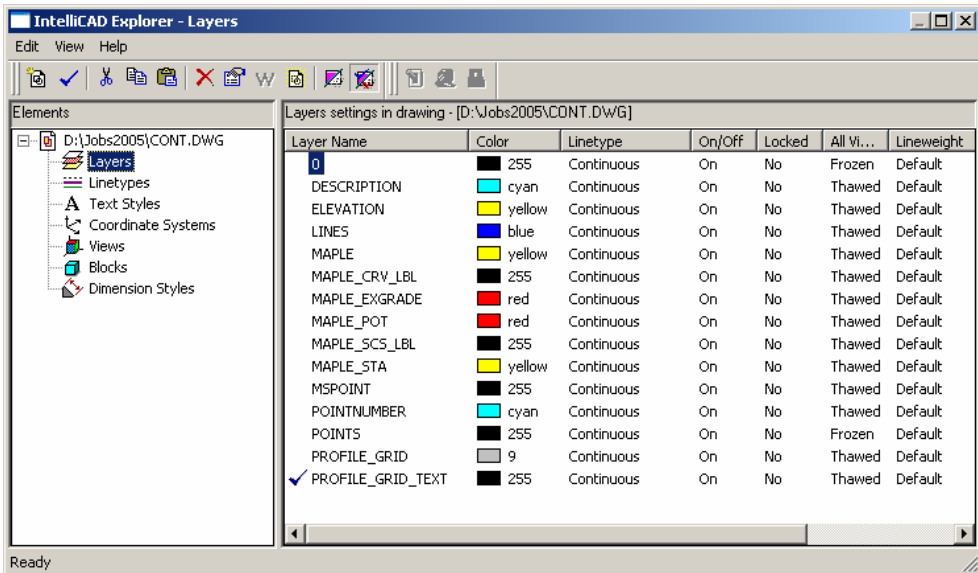

Pick **OK** to continue.

Now the profile will look like this:

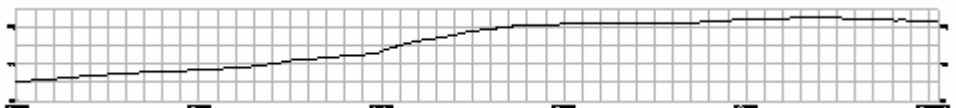

### Design New Profile

Now that we have had a chance to look over our existing profile, we now need to create a design alignment.

Go to the **MsDesign** pulldown menu -> **AutoRoute** and pick on the **Design Vertical Alignment** option.

Draw new profile grid or use existing New/<Existing>: **<Enter>**

Enter vertical alignment name: **<MAPLE>**



\* NOTE \*

When naming a Vertical alignment, be sure to use only a single word, with no spaces, as the name, such as:

ROAD1, Orange\_Side\_Road, Maple\_Street, Pine-Street, Maple

At this point, the program will draw a rubber band line from the bottom left corner of the graph. This helps you to find the starting end of the profile. Pick on the graph where you wish to start the new profile line.

Pick first VPI location: **< pick near the left edge around the existing profile >**

Change the dialog box that comes up, so the station and elevation look like the following;

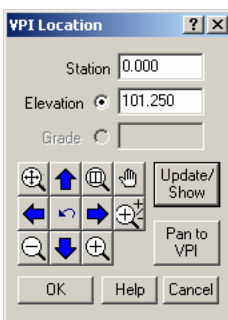

Pick the **OK** button.

Next pick somewhere around the middle of the profile and change the dialog box so the station and elevation match the following;

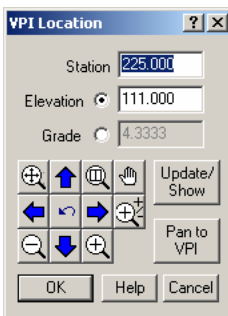

Pick the **OK** button.

---

Lastly pick over near the top right and change the settings so the station and elevation match the following.

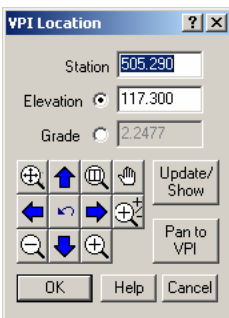

Pick the **OK** button.  
Press **ENTER** to continue.

Next you will be asked:

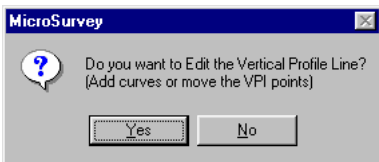

Pick **YES** to continue.

Now you will be prompted,

Add/Curve/Delete/Move: **CURVE**

Select VPI: **<Pick the Red Circle at the FIRST bend in the vertical alignment>** (zoom in if you need to, to be able to pick the red circle cleanly – don't miss it)

Enter or pick curve length: **150 <Enter>**

Select VPI: **<ENTER>**

Add/Curve/Delete/Move: **<ENTER>**

---

Next you will be asked if you wish to pass our cross section template along the design alignment and create a new surface.

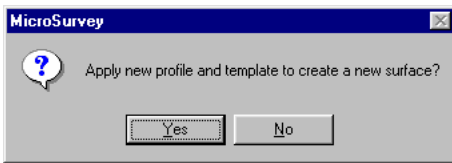

Answer **NO** for now because we need to create the template first.

Before we do the Cross Section Template, let's label the vertical curve. Go to the **MsDesign** pulldown menu -> **AutoRoute** and pick on the **Query/Label VPI** option.

Select existing VPI: **<Pick the Red Circle at the FIRST bend in the vertical alignment>** (zoom in if you need to, to be able to pick the red circle cleanly – don't miss it)

You will see the following dialog box.

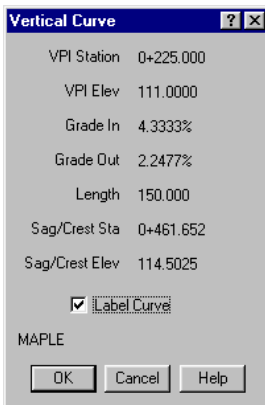

Be sure to pick the **Label Curve** box to turn it on. Then pick the **OK** button to continue.

The curve will be label as shown below:

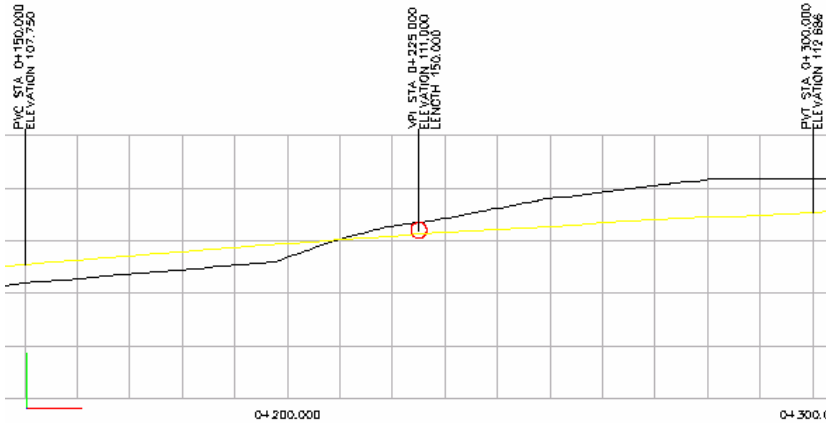

Select existing VPI : <enter>

**Note: if nothing appears, check the layering to make sure that the items are not in white on a white background.**

### Create Cross Section Template

Before we create the template let us save the Vertical Design file;

Go to the **MsDesign** pulldown menu -> **AutoRoute** and pick on the **Write .VRT File** option.

The command prompt will display the following to confirm it was saved.

```
C:\Jobs2005\PGRID-0.VRT saved.
```

Now lets create a template for our road cross section.

Go to the **MsDesign** pulldown menu -> **AutoRoute** and pick on the **Create Cross Section Template** option.

You will see a template editor on screen. This editor has many options that need to be filled out.



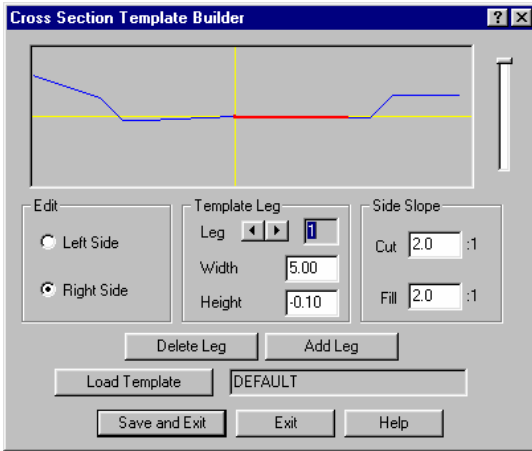

Set each leg to the values shown.

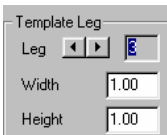
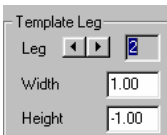
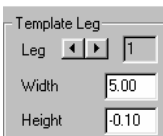

delete leg 4,

Set the cut slope = 3.0 and fill slope = 2.0.

Repeat legs 1 to 4 for the left side. Once completed your template should look like the following.

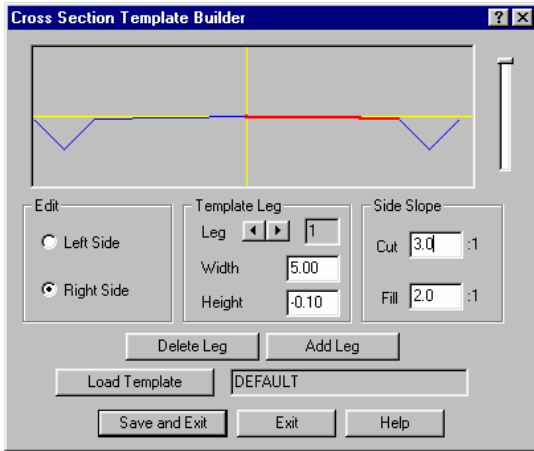

Pick the **SAVE** and **EXIT** button.

This will allow you to save the template for future use.  
Give the template the name of **MAPLE**, as shown.

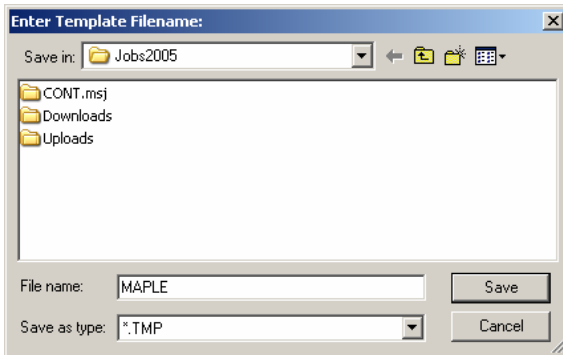

Pick the **SAVE** button to continue.

The following message is placed in the command prompt window.  
Cross section template file saved as C:\Jobs2005\MAPLE.TMP.

---

## Create New Road Surface

Now that the cross section template is complete, we can now apply it to the design alignment. Go to the **MsDesign pulldown menu -> AutoRoute** and pick on the **Create New Design Surface** option.

You will then see the following dialog box:

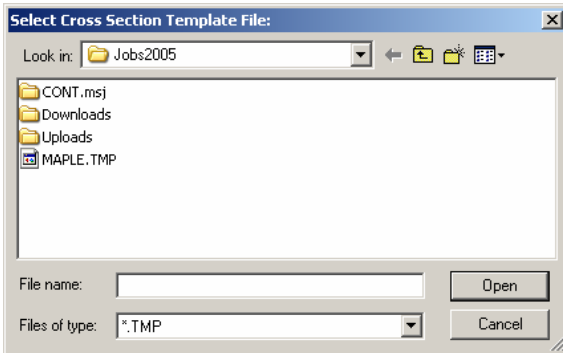

Pick on our **MAPLE** template then pick the **OPEN** button to continue.

The following dialog comes up next,

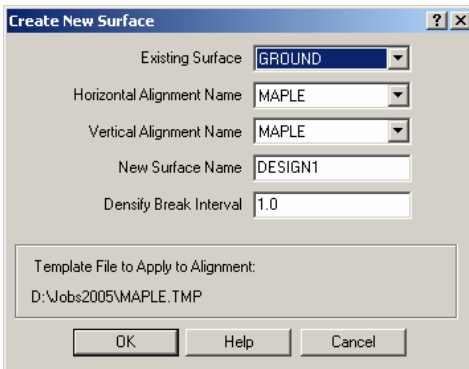

You need to confirm the surface and alignment names match the box shown above. Press the **OK** button.

After a short period of time (a few seconds or so), the following prompt appears in the command window.

---

Draw or Show new TIN? Draw/Show/Noshow:

<Pick **SHOW** to see the TIN>

You will then see a dialog asking you if you want to create cross section data for later export to LandXML file, say **NO** to this.

Your drawing should now look like this:

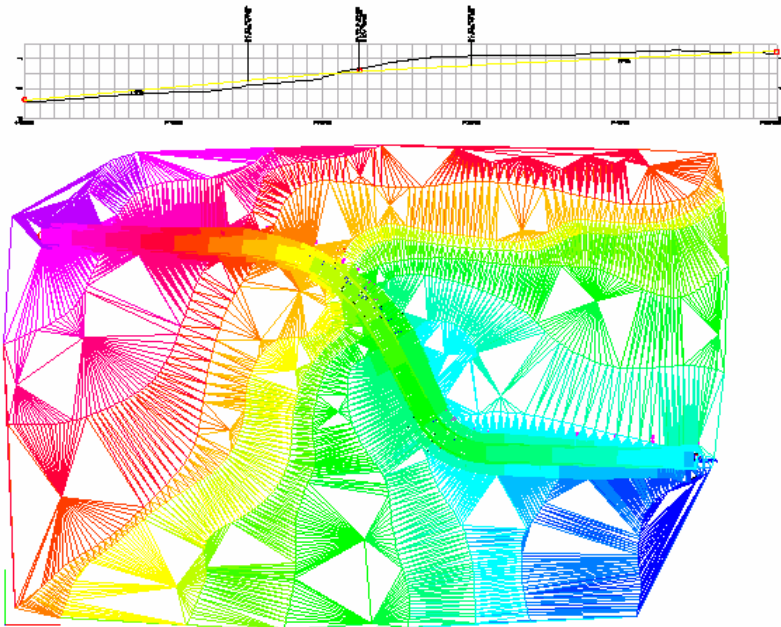

After seeing the TIN you can hit the **redraw** button to clear the TIN. The Surface does stay in memory for future use.

What you will now see on screen is the road with the template applied, showing the outer edge where the template intersects with the original surface.

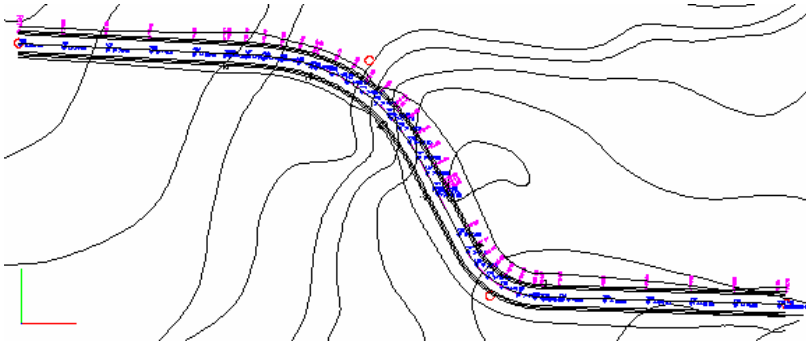

## Output Cross Sections

Now lets get some cross sections along the alignment.

Go to the **MsDesign** pulldown menu -> **AutoRoute** and pick on the **Extract Cross Sections from Alignment** option.

Be sure to set the next dialog box exactly as shown below to ensure you get the correct results. Special attention to ensure you select **BOTH** surfaces as shown.

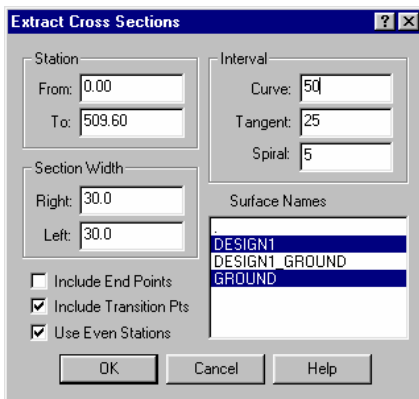

Pick the **OK** button to continue.

This will draw lines on the plan view of the alignment to show where the cross sections will be extracted from.

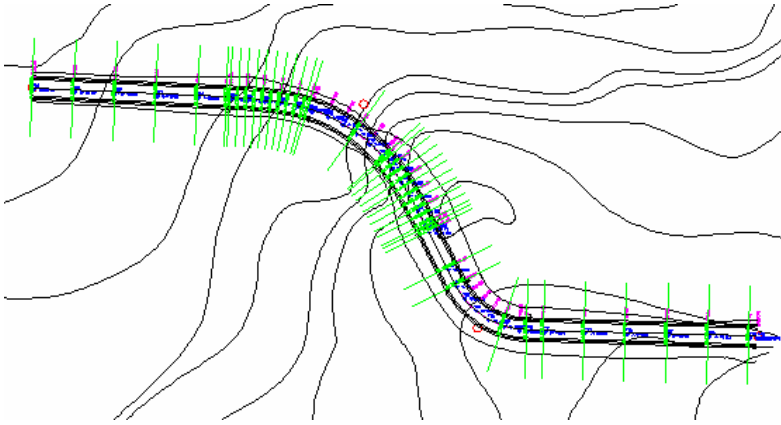

Then:

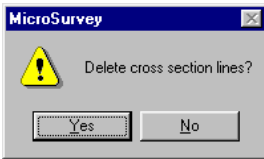

Answer **NO**.

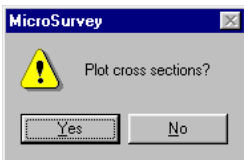

When you answer **YES** you will be shown another dialog box that controls the output of the sections. Please fill it out exactly as shown:

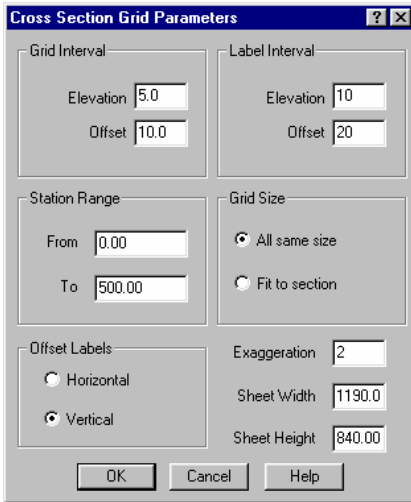

Pick the **OK** button to continue.

Pick lower left corner: **<this is the starting location for the sections to be drawn>** (go to the right of the drawing so they do not overlap on screen)

You will see the sheet size outlined and the sections draw within the sheet.

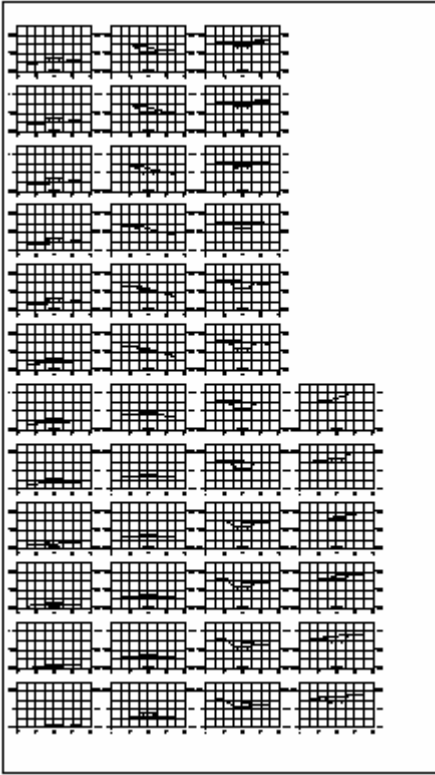

Changed the color of Layer **GRID** to gray (9) as we did above for the profile. Here is a close up of a few of the sections:

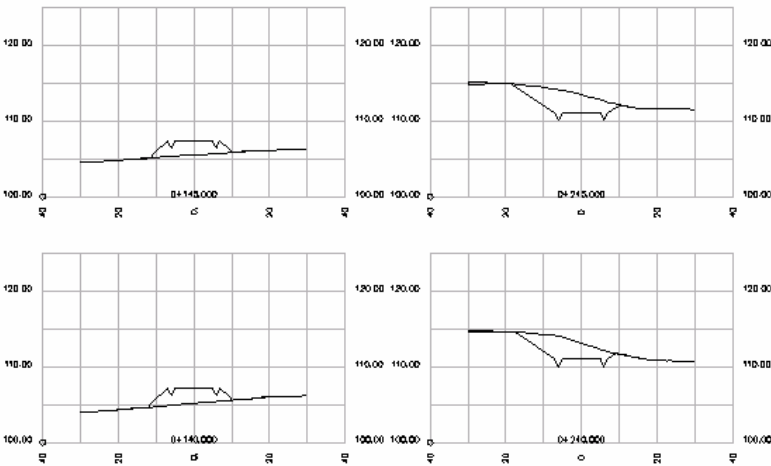



---

Be sure to save the drawing and the surfaces, as we covered in a previous tutorial.

(End of tutorial)

---

## House Placement Tutorial

Because of the size and complexity of this tutorial we have broken it down into 9 smaller steps to make it easier for you to follow.

Step 1) Open the Job

Step 2) Working with the Toolbox

Step 3) Entering a Lot

Step 4) Defining the Lot Sides

Step 5) Entering a House

Step 6) Defining a House

Step 7) Placing a House on the Lot

Step 8) Computing Stakes

Step 9) Staking Reports

### Open the Job

To begin, start a new drawing by running the New ... command, found under the **File drop-down menu**.

Pick the New button on the Project Manager, and name the job **LOT**.

Pick **Save** to continue.

Next you will see the following dialog box.  
Set the defaults as shown here

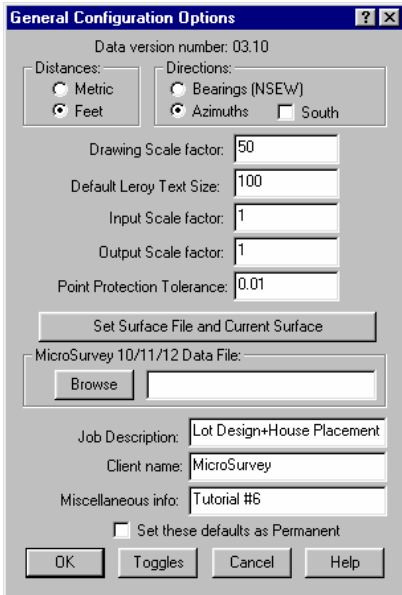

At the bottom of the above dialog box, pick on the **Toggles** button. This brings up the following dialog boxes. Set the Toggles as shown here.

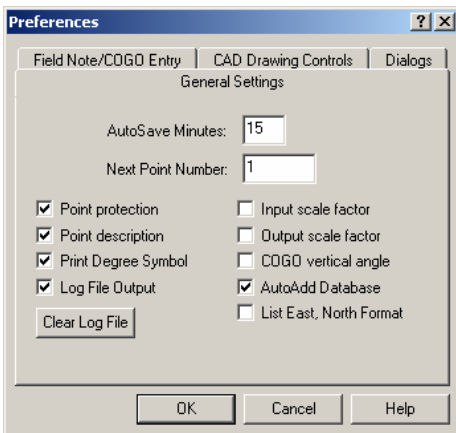

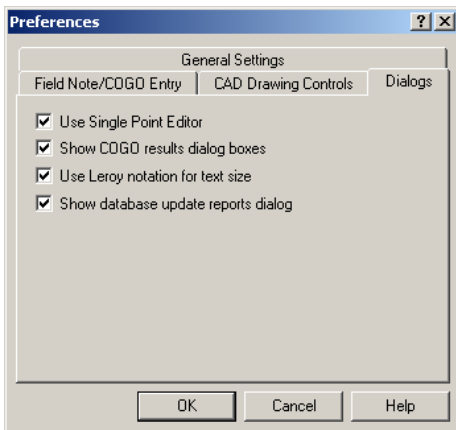
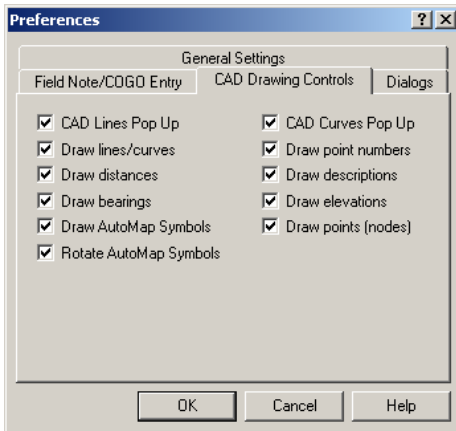
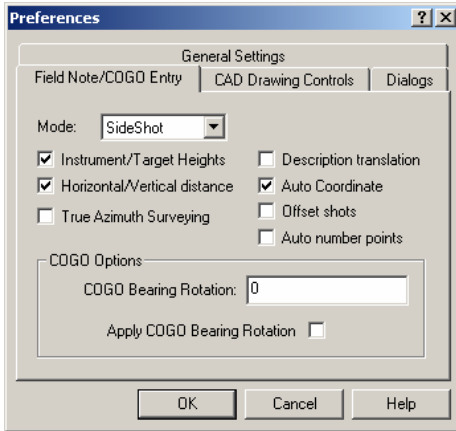

---

Now pick the **OK** button to return to the previous dialog and pick **OK** again to exit and save the settings in that dialog box.

If the MicroSurvey Assistant comes up on screen – pick the **EXIT** button to remove it from the screen.

### Working with the Toolbox

Go to the **MsTools** pulldown menu -> **Subdivision Palette...** option.



The toolbox can be dragged to any location on screen (by picking in the top bar in the Toolbox and while holding the mouse button down, drag it to the desired location) to make it easy to access but not cover the drawing.

### Entering a Lot

Pick on this button: 

You will now be asked if you are entering a lot or block.

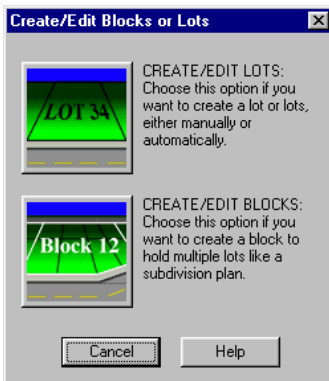

In this example we will pick on the **top button** to enter a Lot.



Now you will be asked which of the 3 different ways you wish to enter the lot information.

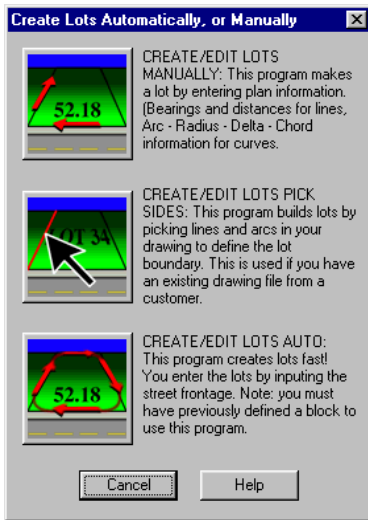

**Pick** on the first button:

Now fill out the next dialog as show, with the lot number.

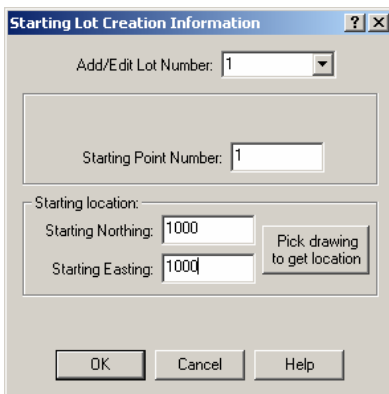

Pick on the **OK** button to continue.

---

You will then be given some reminders on how to enter your lot.

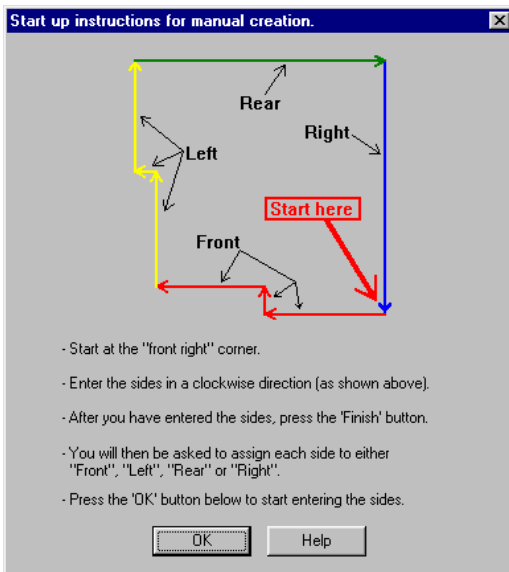

Pick on the **OK** button to continue.

Now you will see the following dialog:

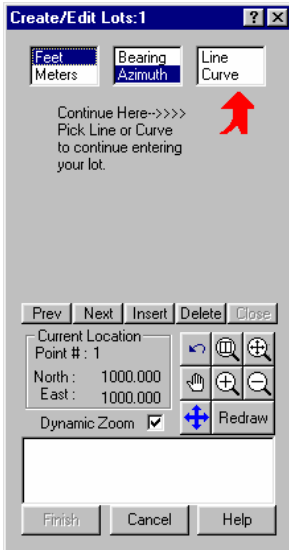

There will be many things to enter on this dialog. To start with you need to tell the routine if you are entering a **line** or **curve** – then press **enter** to continue. Then you will be asked to fill in each piece of information on that line or curve. Press enter after each piece of info has been entered.

Here is what the first series of entries should look like:

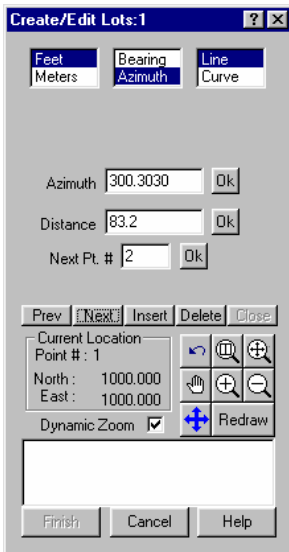

After entering this info – press enter and you will be given the previous dialog again, ready for new numbers. You will also see the lot taking shape in the drawing after each side is entered.

Here are the remain pieces of information for you to enter: Fill in everything, one step at a time as you go, and press enter after each item:



**Create/Edit Lots:1** [?] [X]

Azimuth   
 Distance   
 Next Pt. #

Current Location  
 Point #: 2  
 North: 1042.238  
 East: 928.319

Dynamic Zoom

**Create/Edit Lots:1** [?] [X]

Method

Direction

Chord Azimuth

Radius    
 Arc    
 Delta    
 Chord

Rad Pt:   
 EC

Current Location  
 Point #: 3  
 North: 1159.419  
 East: 972.631

Dynamic Zoom

**Create/Edit Lots:1** [?] [X]

Azimuth    
 Distance    
 Next Pt. #

Current Location  
 Point #: 5  
 North: 1161.147  
 East: 1032.207

Dynamic Zoom

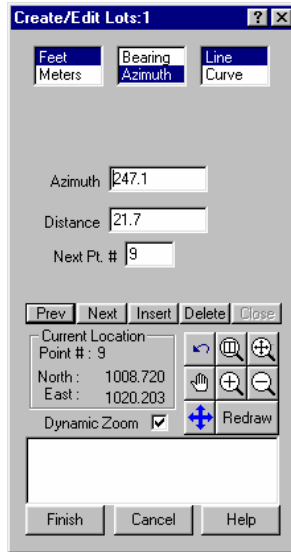
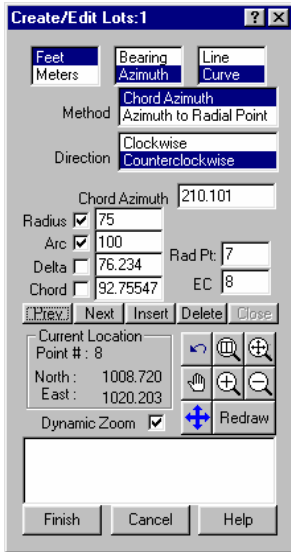

After you enter in all of the info on the last dialog – pick the **FINISH** button to continue.

You will be presented with the following:

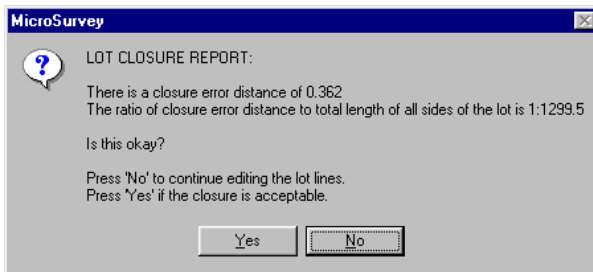

Pick the **YES** button to continue.

---

## Defining the Lot Sides

At this point you have the following lot drawn.

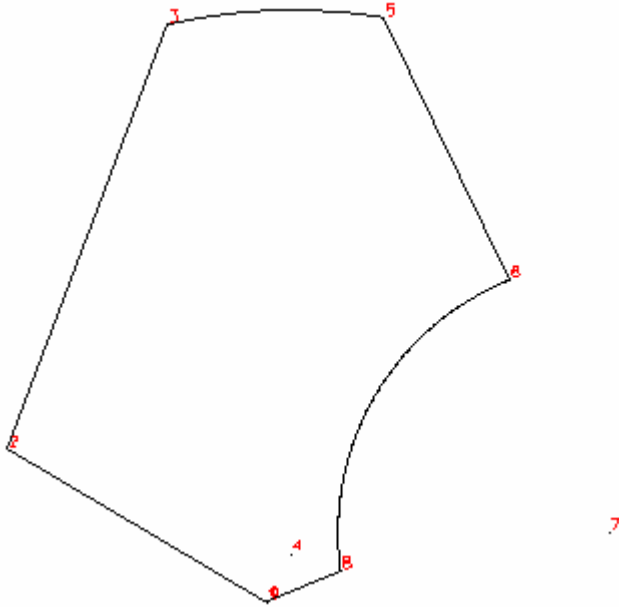

The following dialog is on screen:

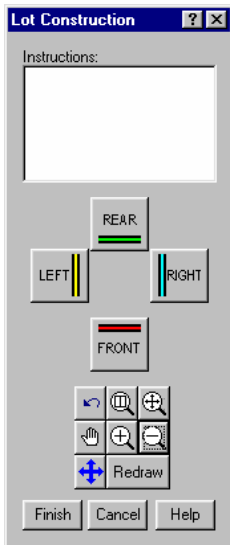

You need to pick on each of the 4 buttons labeled Front, Left, Rear and Right, one at a time and then pick the linework related to the button.

To start, pick the **FRONT** button and then pick the **first line** we drew. Then press **enter** to continue.

Then pick the **LEFT** button and pick the **second line** we drew. Then press **enter** to continue.

Then pick the **REAR** button and pick the **first curve** and the **next line** we drew. Then press **enter** to continue.

Finally pick the **RIGHT** button and pick the **second curve** and **last line** we drew. Then press **enter** to continue.

The lot sides should have changed color to match the buttons on the dialog, as shown below:

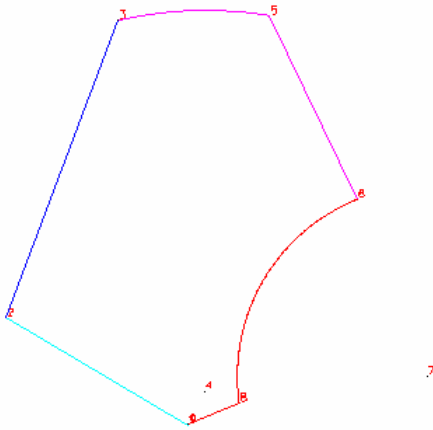

Pick the **FINISH** button to continue.

Next a window will appear showing you the lot report.

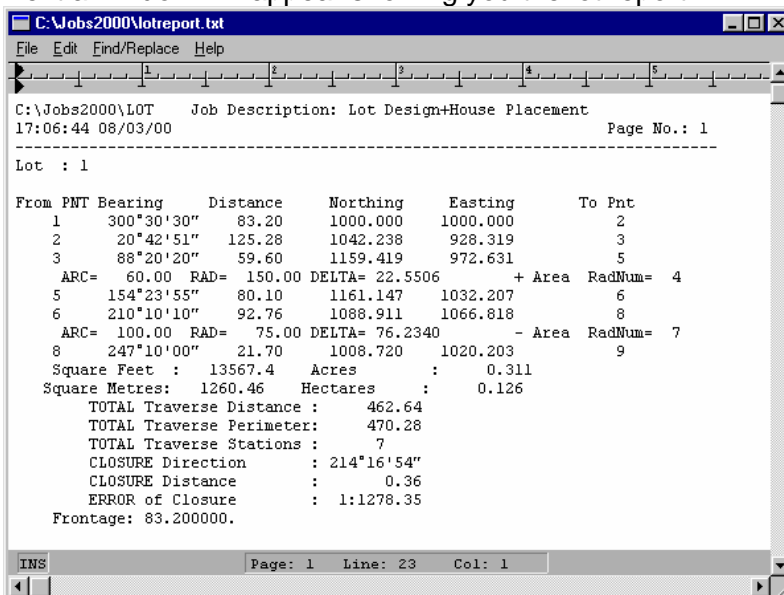

You may print it by going to the **File pulldown menu** in this window and picking the **Print** command.

You may close the window by picking the **X** in the top right corner of the window.

---

Now you will be asked (and it may have been on screen already)

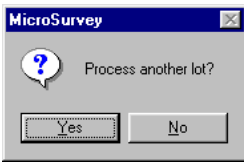

Pick on **NO** to finish the lot entry.

## Entering a House

Pick on this button: 

This will bring up the Building Library dialog.

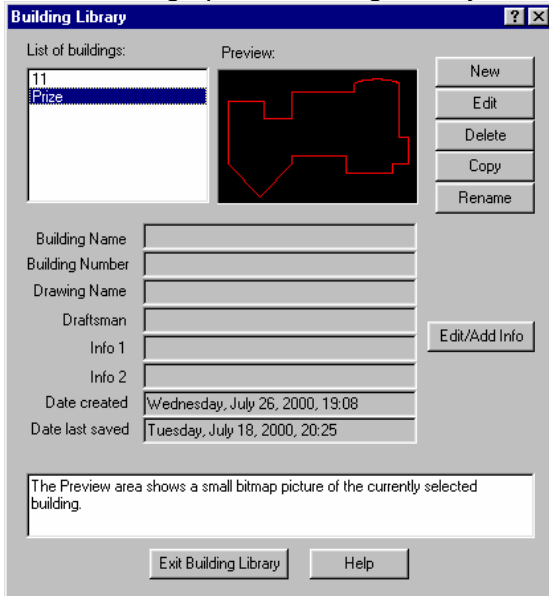

This dialog will display any structures already saved in the library and if you pick on one the preview will show up as well.

Pick on the **NEW** button to add one.

You will be given 2 different ways of entering house data.



We will pick on the first button to continue.



Next give the house a name of **Tutorial** and pick the **OK** button to continue.



At this point a new job is opened to allow you to create the house. You will need to confirm the setup just like you do for other new drawings.

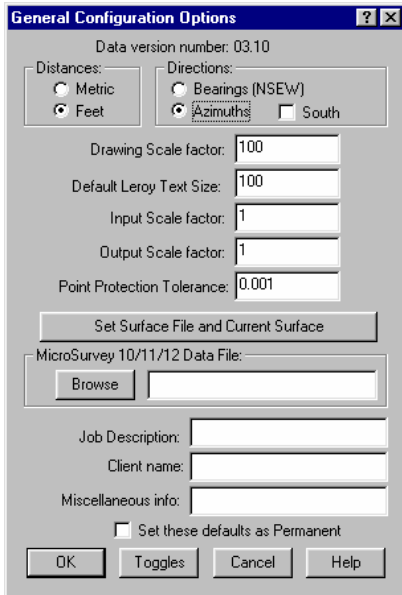

Match the entries in the above dialog and pick the **OK** button to continue.

Similar to the lot entry, the following dialog is displayed as a reminder of how to enter the information.

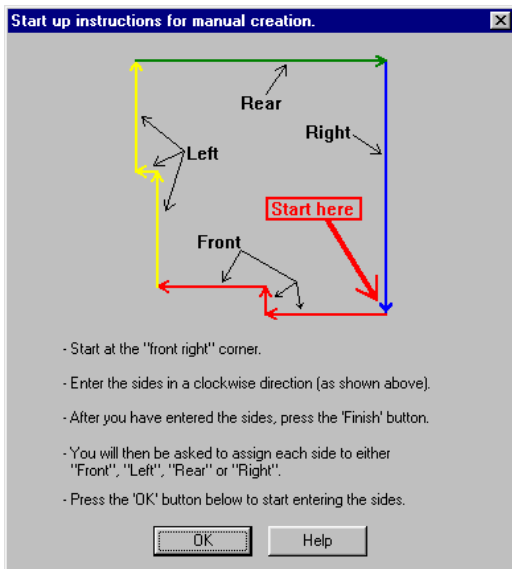



Pick the **OK** button to continue.

Pick each of the entries shown to define the units and direction the line is to be drawn in, and then press enter after each value is entered.

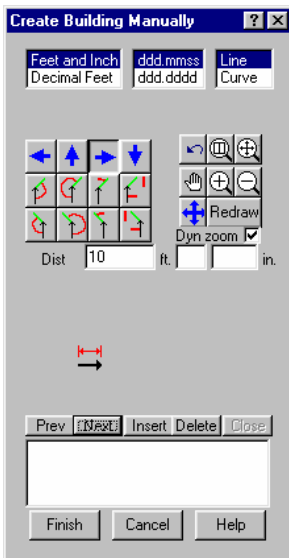
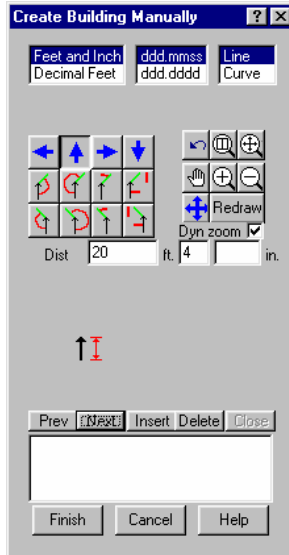
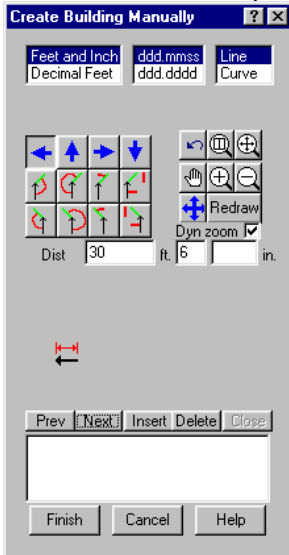

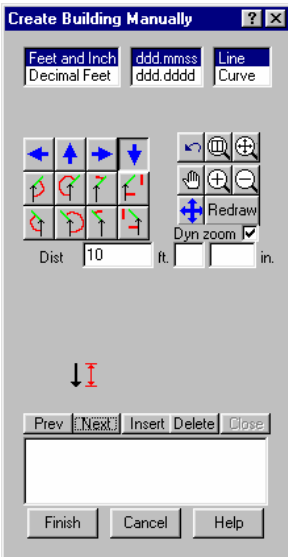
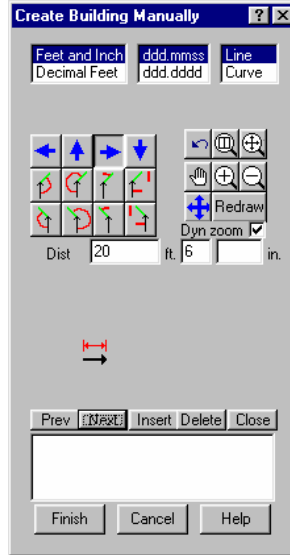
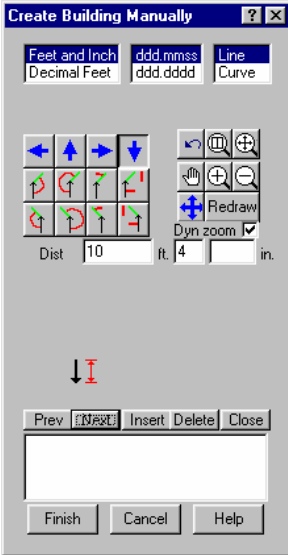

Pick the **FINISH** button to continue.

You will see the following dialog:

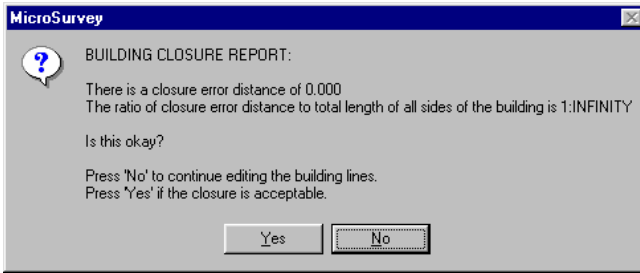

Pick **YES** to continue.

### **Defining a House**

At this point you have the following house drawn.

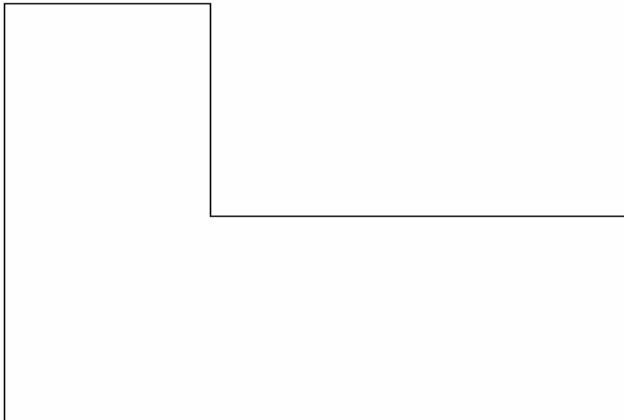

The following dialog is on screen:

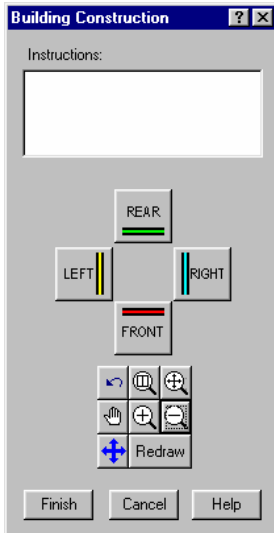

You need to pick on each of the 4 buttons labeled Front, Left, Rear and Right, one at a time and then pick the linework related to the button.

To start, pick the **FRONT** button and then pick the **first line** we drew. Then press **enter** to continue.

Then pick the **LEFT** button and pick the **second line** we drew. Then press **enter** to continue.

Then pick the **REAR** button and pick the **next 3 lines** we drew. Then press **enter** to continue.

Finally pick the **RIGHT** button and pick the **last line** we drew. Then press **enter** to continue.

Pick the **FINISH** button to continue.

Your house has now been saved in the house library and you are returned to the Building Library dialog. Pick on your house name and you will see the preview, as shown below:

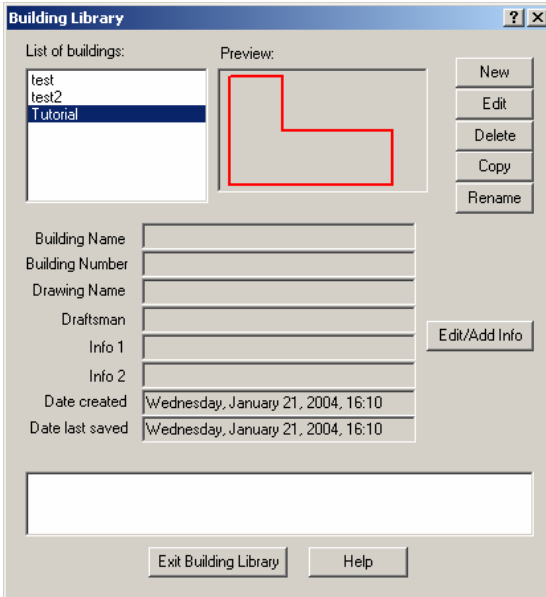

Pick the **Exit Building Library** button to continue.

### **Placing a House on the Lot**

Now we need to place the House on the Lot. We do this by picking this button from the toolbox.



It will bring up the following dialog box. Fill it out as shown.

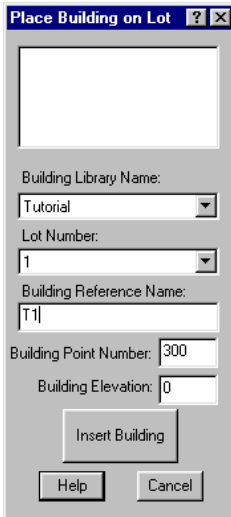

Once you pick the **Insert Building** button, the house we designed will now be attached to your crosshair and is ready for placement.

**NOTE:** As you move the house around you can see the side ties update dynamically. You can switch between rotating, translating and scaling the house by following the instructions on the dialog. You may move the dialog out of the way by picking the top bar and dragging it to the side.

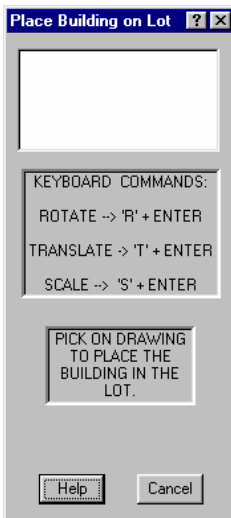

You will see the house ties update as the house is moved in any direction, giving you the closest tie to the property line, in each direction

Here are a couple of examples as we move the house around and rotate it to get what we desire.

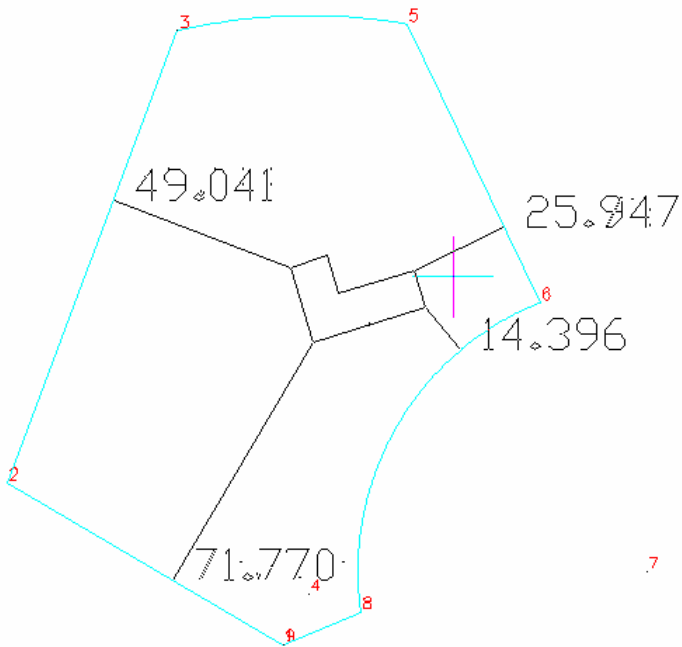
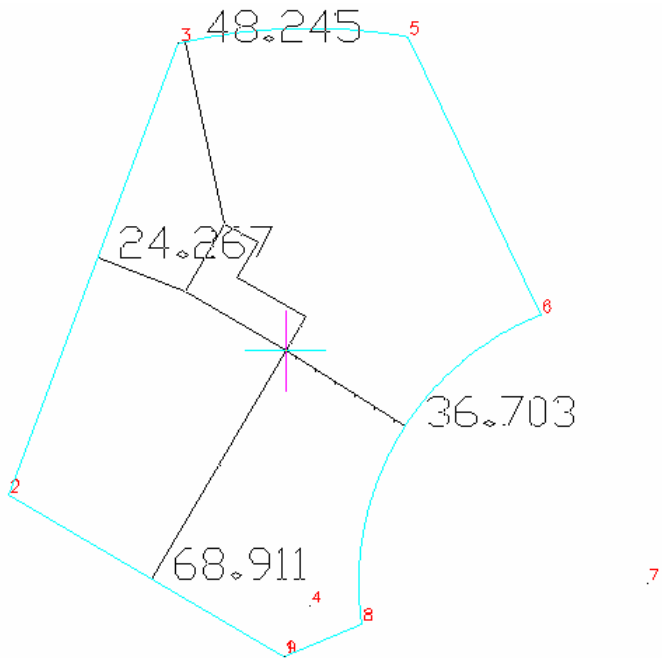

Now we need to pick the desired location with the mouse, to place the house roughly on the lot.

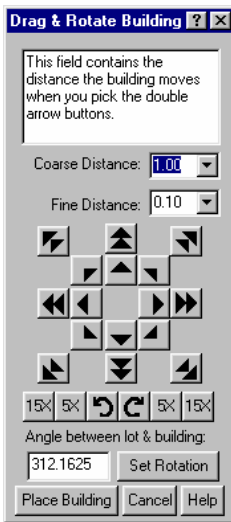

Once the house has been placed roughly on the lot, you will have the ability to fine-tune the exact location by using this “Tuner” dialog.

You have course and fine control with the outer and inner directional buttons. You can also specify the amount of movement for the two settings. You may also rotate the house by the rotation arrows and even set the rotation based upon the angle between the house and the lot.

You decide where you wish to place your house. Mine is set as shown.

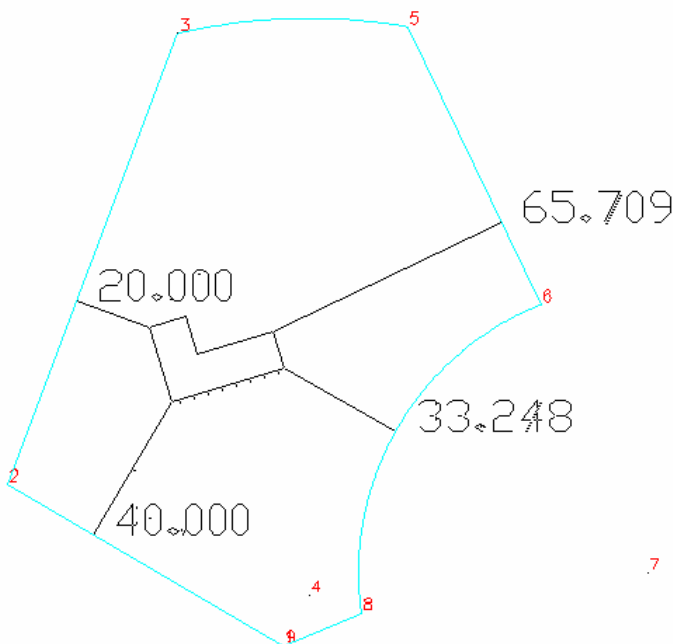



---

When you are happy with the final placement then pick the **Place Building** button to continue.

Your house is now coordinated and points are placed on the house corners based upon the starting number and elevations set earlier.

### Computing Stakes

Now that you have the house on the lot, we need to add a few stakes to make it easier for the construction crew to layout the house in the field.

We will add a few stakes around the footprint of the house, offset back from the actual footprint. To do this we will go to the **MsPoints drop-down menu -> Compute Points and pick the Compute Stakes... option**. Set the starting point number and offsets as shown below:

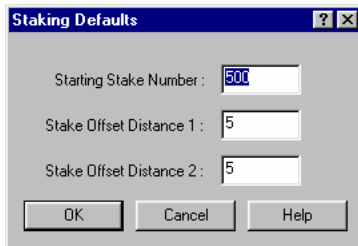

Pick the **OK** button to continue.

The following dialog box will now appear to let you choose the method of placing stakes.

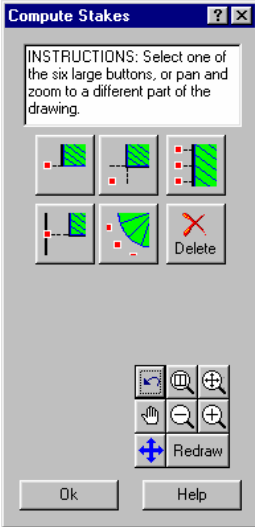

Pick this button to place stakes at the building corners, offset from each line.



Now you will see the following dialog box:

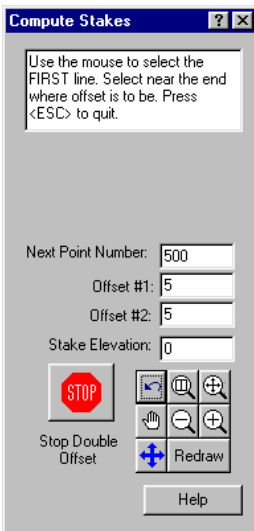

Confirm the starting point number and offsets and elevation of the points you are about to place.

---

Then pick the house sides where you wish to place points. Pick the sides so that you get points as shown below: (The white window at the top of the dialog box will give you instructions to walk you through placing points)

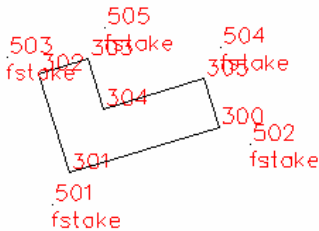

Pick the **STOP** button to end placing new points and return to the previous dialog. Set other points if you desire, by using some of the other routines.

Pick the **OK** button to end the command.

### **Staking Reports**

Now that we have some stakes set, we need to generate a staking report for the field crew.

Go to the **MsPoints drop-down menu -> and pick on the Create Stakeout Report...** option.

You will see the following dialog box:

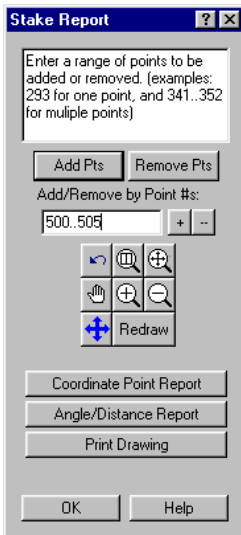
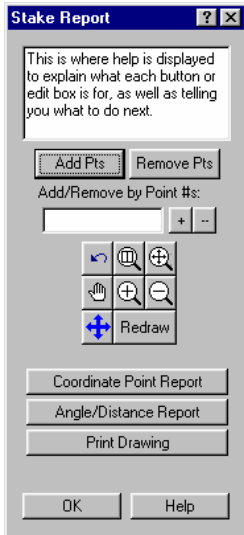

In the small white rectangle, enter in the point range for the stakes. In my example I typed **500..505**

Then pick the **+** sign to the right.

The points on screen should now have little yellow **X's** on them, like this:

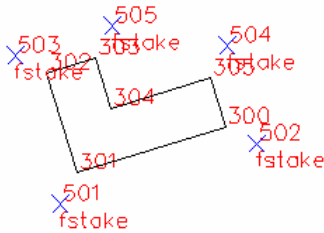

Now pick on the **Coordinate Point Report** button.  
Then confirm the report file location and name:

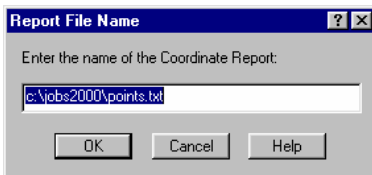

Pick the **OK** button to continue.

The coordinate report is created and displayed in our editor. You may print this report by going to the **File pulldown menu → Print**.

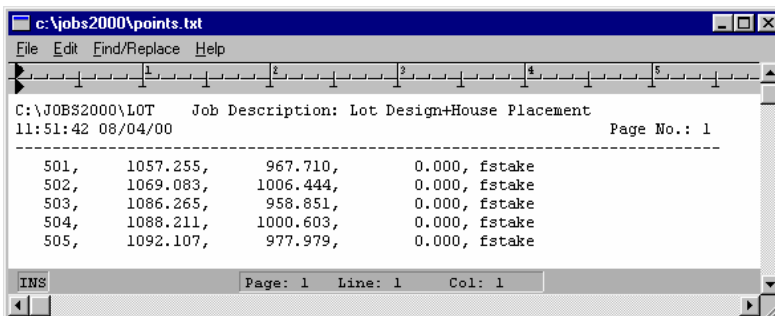

You may close the window by picking the **X** in the top corner of the window.

Now pick on the **Angle/Distance Report** button.  
Then confirm the report file location and name:



Pick the **OK** button to continue.

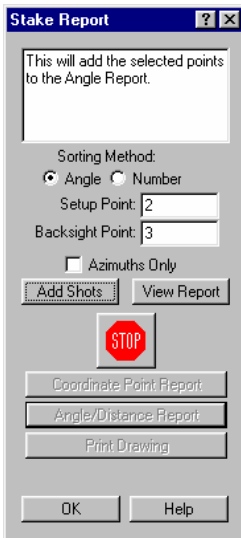

Enter in the **setup** and **backsight** point numbers as show, and pick on the **sorting method** (we will do **Angle** first then **Number**), then pick on the **Add Shots** button. (now do the **Number** option and pick **Add Shots** again)

The drawing will have yellow lines from the setup to each stake. They are temporary and will be removed with a **redraw** or **zoom command**.

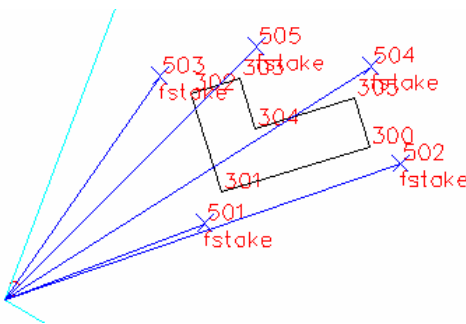

Now pick the **View Report** button to see the two reports we generated.

```

c:\jobs2000\angles.txt
File Edit Find/Replace Help
-----
C:\JOBS2000\LOT Job Description: Lot Design+House Placement
11:57:22 08/04/00 Page No.: 1
-----
Stakeout report:
Setup Point#: 2 Backsight Point#: 3
-----
Pt#      Angle      Distance      Northing      Easting      Elevation      Description
-----
503      14.0136     53.579       1086.265     958.851     0.000         fstake
505      24.0957     70.378       1092.107     977.979     0.000         fstake
504      36.4945     85.666       1088.211     1000.603    0.000         fstake
501      48.2503     42.157       1057.255     967.710     0.000         fstake
502      50.1919     82.610       1069.083     1006.444    0.000         fstake
-----
Stakeout report:
Setup Point#: 2 Backsight Point#: 3
-----
Pt#      Angle      Distance      Northing      Easting      Elevation      Description
-----
501      48.2503     42.157       1057.255     967.710     0.000         fstake
502      50.1919     82.610       1069.083     1006.444    0.000         fstake
503      14.0136     53.579       1086.265     958.851     0.000         fstake
504      36.4945     85.666       1088.211     1000.603    0.000         fstake
505      24.0957     70.378       1092.107     977.979     0.000         fstake
-----
INS Page: 1 Line: 1 Col: 1

```

The first was sorted by *Angles* the second by *Point Numbers*.

You may print this report by going to the **File pulldown menu** (in this window) and pick the **Print** option.

You may close the window by picking the **X** in the top corner of the window.

Pick the **OK** button to continue.

Save your job by going to the **File pulldown menu** and picking on the **SAVE** option.

(End of tutorial)